

Features

1. Effective for suppressing noise at high frequencies
2. Suited for preventing the abnormal oscillation from high frequency amplifying circuits.
3. Excellent solder heat resistance for soldering.
4. High reliability in the circuits of high-current

Applications

1. Noise suppression in digital equipments.
2. Computers and peripheral devices, VCR and camera.
3. Noise suppression in automotive electronic equipment, car stereo, car engine controller.
4. Noise suppression for OA electronic instruments.

Ordering Information

HB - **1** **M** **1608** - **121** **J** **T**
 (1) (2) (3) (4) (5) (6)

(1) Series

HB : For Signal line
 HH : For high current (~3.0A)
 HU : For ultra high current (~6.0A)

(2) Material & Design

L, Y : For ultra high speed
 S, B : For high speed
 H,C : For general purpose
 M,P : For high impedance type
 T, V : For Low speed

(3) Dimension

First two digits : length (mm)
 Last two digits : width (mm)

(4) Impedance (at 100MHz)

First two digits are impedance values.
 Last digit is the number of zeros

(5) Termination

J : Nickel barrier

(6) Packaging

B : Bulk package
 T : Tape & Reel (Φ178mm [7 inches])
 L : Tape & Reel (Φ254mm [10 inches])

Shape and Dimensions

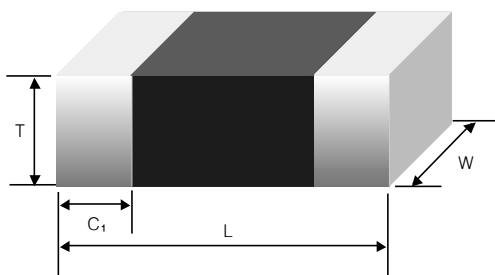

Unit : mm [inches]

Type	L	W	T	C
H□-1□0603-	0.6±0.03 [.024±.001]	0.3±0.03 [.012±.001]	0.3±0.03 [.012±.001]	0.15±0.05 [.006±.002]
H□-1□1005-	1.0±0.05 [.039±.002]	0.5±0.05 [.020±.002]	0.5±0.05 [.020±.002]	0.20±0.10 [.008±.004]
H□-1□1608-	1.6±0.15 [.063±.006]	0.8±0.15 [.031±.006]	0.8±0.15 [.031±.006]	0.30±0.20 [.012±.008]
H□-1□2012-	2.0±0.20 [.079±.008]	1.25±0.20 [.049±.008]	1.0±0.20 [.039±.008]	0.50±0.30 [.020±.012]
	2.0±0.20 [.079±.008]	1.25±0.20 [.049±.008]	*1.25±0.20 [.049±.008]	0.50±0.30 [.020±.012]
H□-1□3216-	3.2±0.20 [.126±.008]	1.6±0.20 [.063±.008]	1.3±0.20 [.051±.008]	0.50±0.30 [.020±.012]
H□-1□4516-	4.5±0.25 [.177±.010]	1.6±0.20 [.063±.008]	1.3±0.20 [.051±.008]	0.50±0.30 [.020±.012]
H□-1□4532-	4.5±0.25 [.177±.010]	3.2±0.25 [.126±.010]	1.3±0.25 [.051±.010]	0.70±0.40 [.027±.016]
H□-1□5750-	5.7±0.30 [.225±.012]	5.0±0.30 [.198±.012]	1.6±0.25 [.063±.010]	0.80±0.50 [.031±.020]

* Only HU Series

Specifications
HB series (For signal line)
HB0603

Part No.	IZI at 100MHz(Ω)		DC Resistance (Ω) max.	Rated current (mA) max.
	typ.	min.		
HB-1T0603-80□□	80	60	0.5	500
HB-1T0603-121□□	120	90	0.8	200
HB-1T0603-241□□	240	180	1.0	200

HB1005

Part No.	IZI at 100MHz(Ω)		DC Resistance (Ω) max.	Rated current (mA) max.
	typ.	min.		
HB-1H1005-100□□	10	7.5	0.05	1000
HB-1M1005-400□□	40	30	0.15	900
HB-1M1005-600□□	60	45	0.20	650
HB-1M1005-800□□	80	60	0.20	650
HB-1M1005-121□□	120	90	0.30	500
HB-1M1005-221□□	220	165	0.35	500
HB-1M1005-301□□	300	225	0.45	400
HB-1M1005-471□□	470	355	0.55	300
HB-1M1005-601□□	600	450	0.60	300
HB-1M1005-102□□	1000	750	1.30	250
HB-1T1005-100□□	10	7.5	0.05	1000
HB-1T1005-260□□	26	19.5	0.10	900
HB-1T1005-400□□	40	30	0.10	900
HB-1T1005-600□□	60	45	0.20	650
HB-1T1005-700□□	70	53	0.20	650
HB-1T1005-800□□	80	60	0.25	550
HB-1T1005-121□□	120	90	0.25	500
HB-1T1005-221□□	220	165	0.35	500
HB-1T1005-241□□	240	180	0.40	400
HB-1T1005-301□□	300	225	0.45	400
HB-1T1005-601□□	600	450	0.60	400
HB-1S1005-100□□	10	7.5	0.10	500
HB-1S1005-300□□	30	23	0.20	400
HB-1S1005-600□□	60	45	0.30	350
HB-1S1005-101□□	100	75	0.35	300
HB-1S1005-121□□	120	90	0.40	300

HB1608

Part No.	IZI at 100MHz(Ω)		DC Resistance (Ω) max.	Rated current (mA) max.
	typ.	min.		
HB-1H1608-300□□	30	22	0.08	500
HB-1M1608-600□□	60	45	0.09	200
HB-1M1608-800□□	80	60	0.10	200
HB-1M1608-121□□	120	90	0.12	200
HB-1M1608-221□□	220	165	0.20	200
HB-1M1608-301□□	300	225	0.30	200
HB-1M1608-501□□	500	375	0.40	200
HB-1M1608-601□□	600	450	0.40	200
HB-1M1608-801□□	800	600	0.60	200
HB-1M1608-102□□	1000	750	0.60	150
HB-1S1608-100□□	10	7.5	0.05	300
HB-1S1608-200□□	20	15	0.12	300
HB-1S1608-300□□	30	22	0.12	300
HB-1S1608-400□□	40	30	0.12	300
HB-1S1608-550□□	55	42	0.15	200



ITEM
CHIP FERRITE - BEADS

PAGE

4/35

HB-1S1608-800□□	80	60	0.25	200
HB-1S1608-121□□	120	90	0.25	200
HB-1S1608-221□□	220	165	0.40	200
HB-1T1608-260□□	26	20	0.05	500
HB-1T1608-300□□	30	22	0.05	500
HB-1T1608-600□□	60	45	0.10	400
HB-1T1608-800□□	80	60	0.10	300
HB-1T1608-121□□	120	90	0.20	250
HB-1T1608-221□□	220	165	0.30	200
HB-1T1608-301□□	300	225	0.35	200
HB-1T1608-331□□	330	250	0.35	200
HB-1T1608-601□□	600	450	0.50	200
HB-1T1608-102□□	1000 (at 60MHz)	750	0.70	200
HB-1T1608-202□□	2000 (at 70MHz)	1500	1.20	100
HB-1B1608-222□□	2200	1650	0.85	200

HB2012

HB-1H2012-150□□	15	12	0.02	600
HB-1H2012-260□□	26	20	0.02	600
HB-1H2012-300□□	30	23	0.02	600
HB-1H2012-320□□	32	24	0.03	600
HB-1M2012-800□□	80	60	0.08	300
HB-1M2012-121□□	120	90	0.10	300
HB-1M2012-151□□	150	115	0.12	300
HB-1M2012-221□□	220	165	0.12	300
HB-1M2012-301□□	300	225	0.15	300
HB-1M2012-451□□	450	338	0.25	300
HB-1M2012-601□□	600	450	0.25	300
HB-1M2012-102□□	1000	750	0.30	300
HB-1M2012-202□□	2000 (at 70MHz)	1500	0.50	300
HB-1M2012-252□□	2500 (at 50MHz)	1875	0.60	300
HB-1S2012-5R0□□	5	3.5	0.05	300
HB-1S2012-8R0□□	8	6	0.05	300
HB-1S2012-400□□	40	30	0.15	250
HB-1S2012-800□□	80	60	0.18	200
HB-1S2012-121□□	120	90	0.20	300
HB-1S2012-221□□	220	165	0.30	300
HB-1S2012-251□□	250	190	0.50	300
HB-1T2012-260□□	26	20	0.04	600
HB-1T2012-400□□	40	30	0.05	600
HB-1T2012-800□□	80	60	0.08	300
HB-1T2012-121□□	120	90	0.08	300
HB-1T2012-151□□	150	115	0.08	300
HB-1T2012-221□□	220	170	0.12	200
HB-1T2012-301□□	300	225	0.15	200
HB-1T2012-331□□	330	250	0.15	200
HB-1T2012-401□□	400	300	0.15	200
HB-1T2012-601□□	600	450	0.25	200
HB-1T2012-102□□	1000 (at 60MHz)	750	0.30	200
HB-1T2012-202□□	2000 (at 40MHz)	1500	0.50	200
HB-1T2012-252□□	2500 (at 35MHz)	1875	0.60	200
HB-1B2012-222□□	2200	1650	0.60	300
HB-1B2012-272□□	2700	2025	0.70	300

HB3216

Part No.	IZI at 100MHz(Ω)		DC Resistance (Ω) max.	Rated current (mA) max.
	typ.	min.		
HB-1C3216-350□□	35	26	0.02	600
HB-1H3216-500□□	50	37	0.03	600
HB-1H3216-700□□	70	52	0.05	600
HB-1M3216-121□□	120	90	0.05	300
HB-1M3216-151□□	150	115	0.05	300
HB-1M3216-201□□	200	150	0.08	300
HB-1M3216-301□□	300	225	0.09	200
HB-1M3216-601□□	600	450	0.20	200
HB-1M3216-102□□	1000	750	0.25	200
HB-1S3216-100□□	10	7.5	0.05	300
HB-1S3216-200□□	20	15	0.10	300
HB-1S3216-800□□	80	60	0.25	200
HB-1S3216-251□□	250	190	0.30	200
HB-1S3216-601□□	600	450	0.40	200
HB-1T3216-350□□	35	26	0.03	600
HB-1T3216-500□□	50	37	0.03	600
HB-1T3216-700□□	70	52	0.05	400
HB-1T3216-800□□	80	60	0.05	400
HB-1T3216-121□□	120	90	0.10	300
HB-1T3216-151□□	150	115	0.10	300
HB-1T3216-201□□	200	150	0.15	300
HB-1T3216-601□□	600	450	0.30	200
HB-1T3216-801□□	800	600	0.30	200
HB-1T3216-102□□	1000 (at 60MHz)	750	0.40	200
HB-1T3216-122□□	1200 (at 50MHz)	900	0.40	200
HB-1T3216-202□□	2000 (at 30MHz)	1500	0.50	200

HB4516

Part No.	IZI at 100MHz(Ω)		DC Resistance (Ω) max.	Rated current (mA) max.
	typ.	min.		
HB-1H4516-600□□	60	45	0.02	600
HB-1H4516-700□□	70	52	0.03	600
HB-1M4516-151□□	150	115	0.05	300
HB-1T4516-700□□	70	52	0.05	600

HB4532

Part No.	IZI at 100MHz(Ω)		DC Resistance (Ω) max.	Rated current (mA) max.
	typ.	min.		
HB-1H4532-121□□	120	90	0.04	600
HB-1H4532-151□□	150	115	0.04	600
HB-1T4532-800□□	120	60	0.04	600
HB-1T4532-121□□	120	90	0.04	600

HB5750

Part No.	IZI at 100MHz(Ω)		DC Resistance (Ω) max.	Rated current (mA) max.
	typ.	min.		
HB-1M5750-181□□	180	135	0.08	600

HB series – L Type (For ultra high frequency signal line)

Part No.	IZI at 100MHz(Ω)	IZI at 1 GHz(Ω)	DC Resistance (Ω) max.	Rated current (mA) max.
	typ.	typ.		
HB-1L1608-2R0□□	2.0	20	0.20	300
HB-1L1608-4R0□□	4.0	40	0.25	300
HB-1L1608-5R5□□	5.5	55	0.30	300
HB-1L1608-7R0□□	7.0	80	0.30	300
HB-1L1608-9R0□□	9.0	40 (at 500MHz)	0.40	300
HB-1L1608-110□□	11.0	55 (at 500MHz)	0.40	300
HB-1L1608-130□□	13.0	70 (at 500MHz)	0.50	300
HB-1L1608-150□□	15.0	80 (at 500MHz)	0.50	300
HB-1L2012-3R5□□	3.5	30	0.15	500
HB-1L2012-6R5□□	6.5	30 (at 500MHz)	0.20	500
HB-1L2012-100□□	10.0	50 (at 500MHz)	0.25	500

HB series – Y Type (For ultra high frequency signal line)

Part No.	IZI at 100MHz(Ω)	IZI at 1 GHz(Ω)	DC Resistance (Ω) max.	Rated current (mA) max.
	typ.	typ.		
HB-1Y1608-4R0□□	4.0	40	0.20	300
HB-1Y1608-8R0□□	8.0	90	0.25	300
HB-1Y1608-100□□	10.0	170	0.30	300
HB-1Y1608-150□□	15.0	75(at 500MHz)	0.35	300
HB-1Y1608-200□□	20.0	120(at 500MHz)	0.40	300

HH series (For high current)
HH1005

Part No.	IZI at 100MHz(Ω)		DC Resistance (Ω) max.	Rated current (mA) max.
	Typ.	min.		
HH-1H1005-100□□	10	7.5	0.05	1300
HH-1M1005-221□□	220	165	0.35	800
HH-1M1005-471□□	470	355	0.56	500
HH-1M1005-601□□	600	450	0.60	500
HH-1M1005-102□□	1000	750	0.80	400
HH-1S1005-100□□	10	7.5	0.08	1300
HH-1T1005-100□□	10	7.5	0.05	1300
HH-1T1005-121□□	120	90	0.25	800
HH-1T1005-241□□	240	180	0.31	650
HH-1T1005-601□□	600	450	0.58	500

HH1608

Part No.	IZI at 100MHz(Ω)		DC Resistance (Ω) max.	Rated current (mA) max.
	Typ.	min.		
HH-1H1608-300□□	30	22	0.06	2000
HH-1M1608-600□□	60	45	0.09	1600
HH-1M1608-121□□	120	90	0.14	1100
HH-1M1608-221□□	221	165	0.20	1000
HH-1M1608-301□□	300	225	0.30	900
HH-1M1608-501□□	500	375	0.35	800
HH-1M1608-601□□	600	450	0.35	750
HH-1M1608-801□□	800	600	0.50	650
HH-1M1608-102□□	1000	750	0.50	550
HH-1S1608-100□□	10	7.5	0.05	1500
HH-1S1608-200□□	20	15	0.06	1400

HH-1S1608-300□□	30	22	0.10	1300
HH-1S1608-400□□	40	30	0.12	1300
HH-1S1608-550□□	55	42	0.15	1100
HH-1S1608-800□□	80	60	0.18	1000
HH-1S1608-121□□	120	90	0.20	1000
HH-1S1608-221□□	220	165	0.35	800
HH-1T1608-260□□	26	20	0.05	2000
HH-1T1608-300□□	30	22	0.05	2000
HH-1T1608-800□□	80	60	0.10	1600
HH-1T1608-121□□	120	90	0.15	1100
HH-1T1608-221□□	220	165	0.20	1000
HH-1T1608-301□□	300	225	0.30	900
HH-1T1608-331□□	330	250	0.30	800
HH-1T1608-601□□	600	450	0.40	650
HH-1T1608-102□□	1000	750	0.50	550

HH2012

Part No.	Z at 100MHz(Ω)		DC Resistance (Ω) max.	Rated current (mA) max.
	Typ.	min.		
HH-1H2012-150□□	15	12	0.02	2500
HH-1M2012-260□□	26	20	0.02	3000
HH-1M2012-300□□	30	23	0.02	2500
HH-1M2012-320□□	32	24	0.03	2500
HH-1M2012-600□□	60	45	0.03	3800
HH-1M2012-800□□	80	60	0.08	1500
HH-1M2012-121□□	120	90	0.05	2500
HH-1M2012-151□□	150	115	0.10	1500
HH-1M2012-221□□	220	165	0.05	2200
HH-1M2012-301□□	300	225	0.07	2000
HH-1M2012-451□□	450	338	0.20	1000
HH-1M2012-601□□	600	450	0.10	2000
HH-1M2012-102□□	1000	750	0.30	800
HH-1S2012-5R0□□	5.0	3.5	0.05	3000
HH-1S2012-8R0□□	8.0	6.0	0.03	3000
HH-1S2012-400□□	40	30	0.10	1800
HH-1S2012-800□□	80	60	0.15	1500
HH-1S2012-121□□	120	90	0.20	900
HH-1S2012-221□□	220	165	0.20	900
HH-1S2012-251□□	250	190	0.30	1000
HH-1T2012-260□□	26	20	0.03	3500
HH-1T2012-400□□	40	30	0.05	2000
HH-1T2012-800□□	80	60	0.08	1000
HH-1T2012-121□□	120	90	0.03	3000
HH-1T2012-151□□	150	115	0.08	1000
HH-1T2012-221□□	220	165	0.12	1000
HH-1T2012-251□□	250	190	0.05	2800
HH-1T2012-301□□	300	225	0.15	800
HH-1T2012-331□□	330	250	0.15	800
HH-1T2012-401□□	400	300	0.15	800
HH-1T2012-601□□	600	450	0.25	600
HH-1T2012-102□□	1000 (at 60MHz)	750	0.30	600

HH3216

Part No.	Z at 100MHz(Ω)		DC Resistance (Ω) max.	Rated current (mA) max.
	Typ.	min.		
HH-1H3216-500□□	50	37	0.02	4000
HH-1H3216-700□□	70	52	0.02	4000
HH-1M3216-900□□	90	68	0.02	4000
HH-1M3216-121□□	120	90	0.03	4000

HH-1M3216-151□□	150	115	0.05	2000
HH-1M3216-201□□	200	150	0.08	2000
HH-1M3216-301□□	300	225	0.09	2000
HH-1M3216-501□□	500	375	0.06	3000
HH-1M3216-601□□	600	450	0.06	3000
HH-1M3216-102□□	1000	750	0.25	1000
HH-1S3216-100□□	10	7.5	0.05	3000
HH-1S3216-200□□	20	15	0.10	3000
HH-1S3216-800□□	80	60	0.25	2000
HH-1S3216-251□□	250	190	0.30	2000
HH-1T3216-260□□	26	20	0.03	4000
HH-1T3216-350□□	35	26	0.03	4000
HH-1T3216-500□□	50	37	0.04	3000
HH-1T3216-700□□	70	52	0.05	2500
HH-1T3216-800□□	80	60	0.05	2500
HH-1T3216-121□□	120	90	0.10	2000
HH-1T3216-151□□	150	115	0.10	2000
HH-1T3216-201□□	200	150	0.15	1800
HH-1T3216-601□□	600	450	0.30	1000
HH-1T3216-801□□	800	600	0.30	1000
HH-1T3216-102□□	1000 (at 60MHz)	750	0.30	1000
HH-1T3216-122□□	1200 (at 50MHz)	900	0.40	1000
HH-1T3216-202□□	2000 (at 30MHz)	1500	0.40	1000

HH4516

Part No.	Z at 100MHz(Ω)		DC Resistance (Ω) max.	Rated current (mA) max.
	Typ.	min.		
HH-1H4516-600□□	60	45	0.02	4000
HH-1H4516-111□□	110	83	0.02	4000

HH4532

Part No.	Z at 100MHz(Ω)		DC Resistance (Ω) max.	Rated current (mA) max.
	Typ.	min.		
HH-1H4532-121□□	120	90	0.03	3000
HH-1T4532-121□□	120	90	0.03	3000
HH-1M4532-601□□	600 (at 50MHz)	450	0.04	3000
HH-1M4532-132□□	1300 (at 60MHz)	980	0.05	2700
HH-1B4532-132□□	1300	980	0.05	2700

HH5750

Part No.	Z at 100MHz(Ω)		DC Resistance (Ω) max.	Rated current (mA) max.
	Typ.	min.		
HH-1M5750-401□□	400	300	0.05	2500
HH-1M5750-501□□	500	375	0.08	2500
HH-1T5750-151□□	150	115	0.05	4000

HU series (For ultra high current)

Part No.	Z at 100MHz(Ω)		DC Resistance (Ω) max.	Rated current (mA) max.
	Typ.	min.		
HU-1M2012-400□□	40	30	0.02	5000
HU-1M2012-600□□	60	45	0.02	4800
HU-1M2012-800□□	80	60	0.02	4500
HU-1M2012-121□□	120	90	0.03	4200
HU-1T2012-500□□	50	37	0.015	5000
HU-1H3216-500□□	50	37	0.01	4800
HU-1H3216-121□□	120	90	0.02	4600
HU-1H4516-600□□	60	45	0.015	5400
HU-1B4532-681□□	680	510	0.03	3800

HU-1H4532-121□□	120	90	0.02	4600
HU-1M5750-401□□	400	300	0.03	5500

※ Parts with other electrical characteristics available upon request.
 ※ Test equipment : HP4291A + HP16192A

Electrical Characteristics

■ HB1005

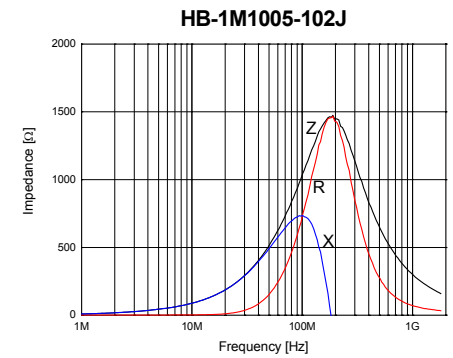
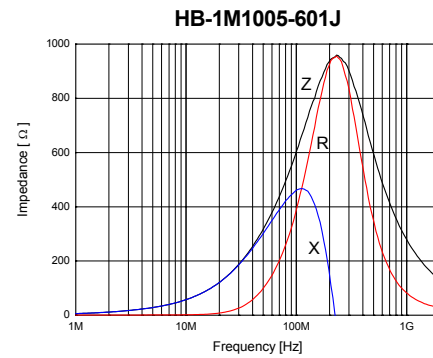
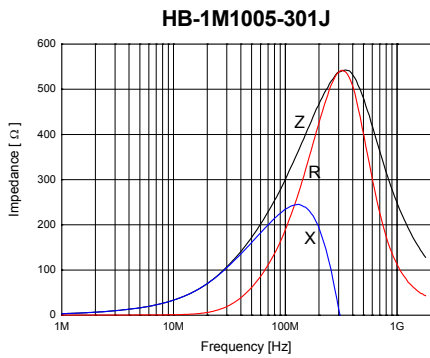
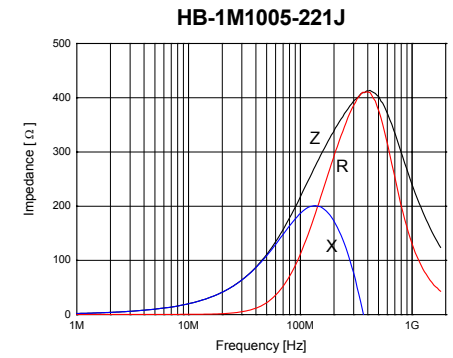
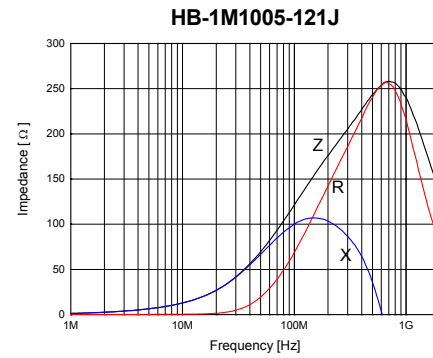
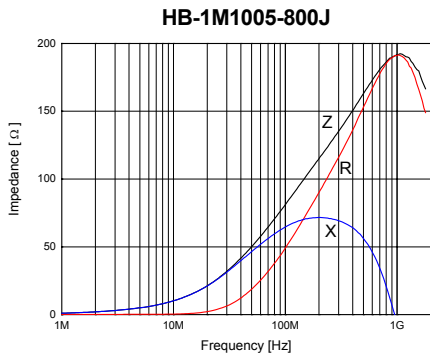
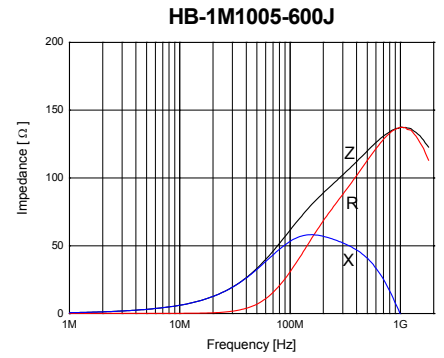
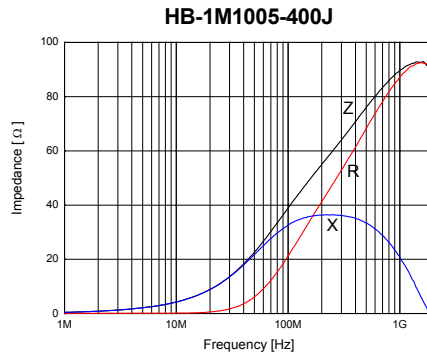
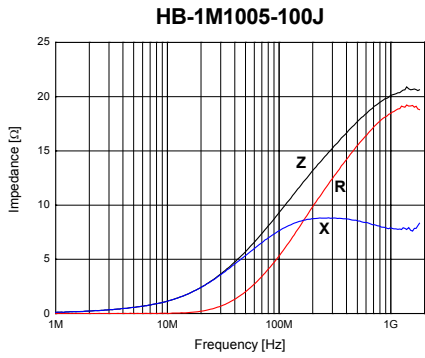

HB-1T1005-100J

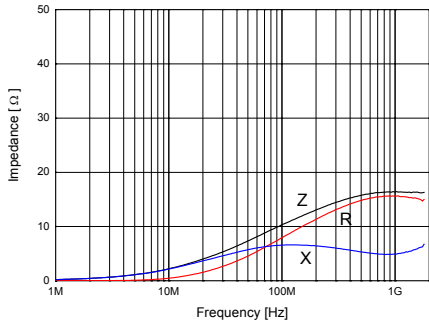

HB-1T1005-400J

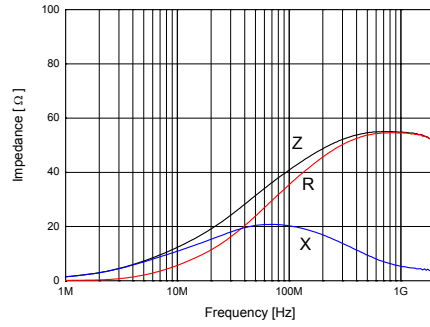

HB-1T1005-600J

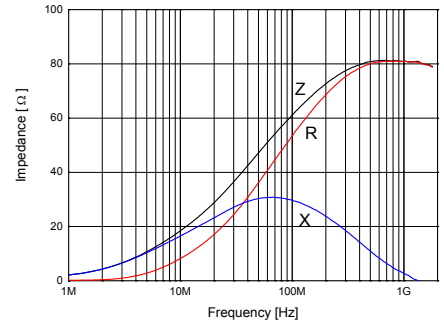

HB-1T1005-700J

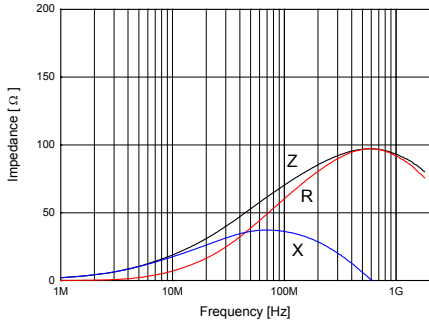

HB-1T1005-800J

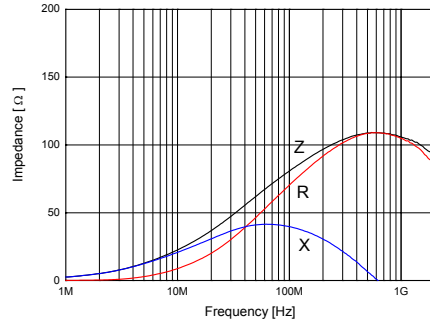

HB-1T1005-121J

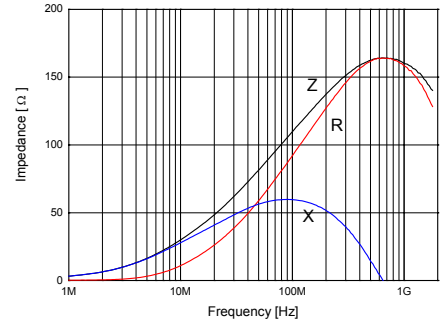

HB-1T1005-221J

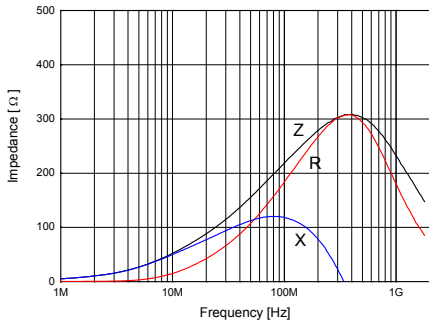

HB-1T1005-241J

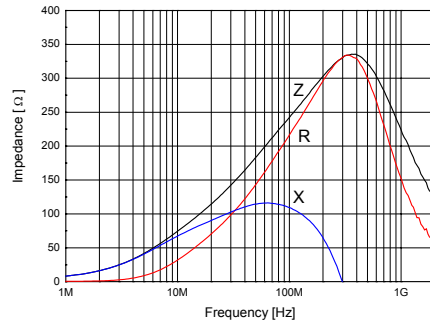

HB-1T1005-301J

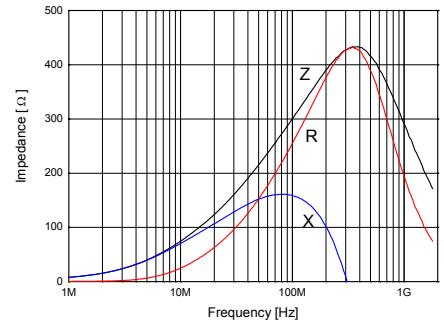

HB-1T1005-601J

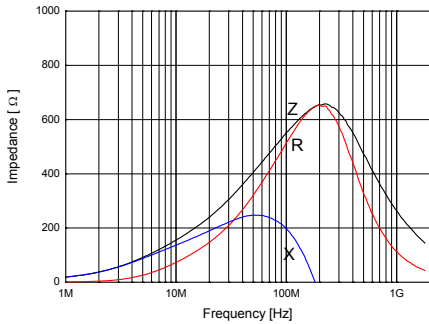

HB-1S1005-100J

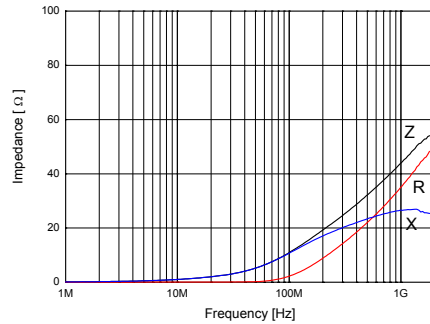

HB-1S1005-300J

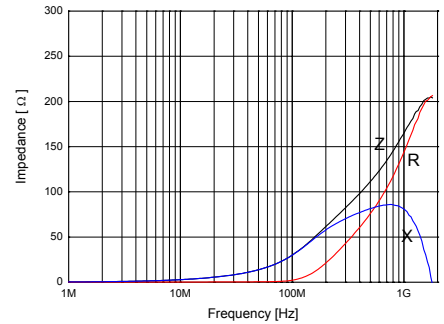

HB-1S1005-600J

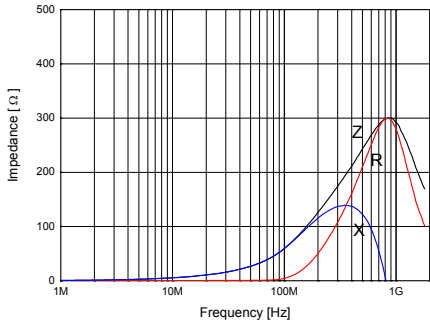

HB-1S1005-101J

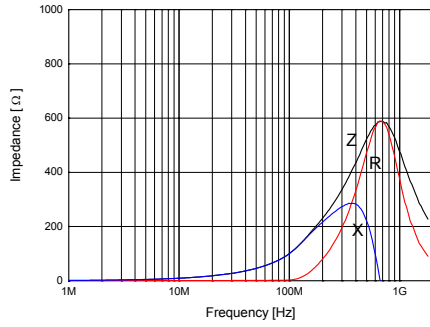

■ HB1608

HB-1H1608-300J

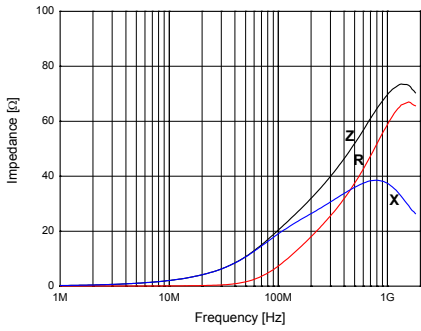

HB-1M1608-600J

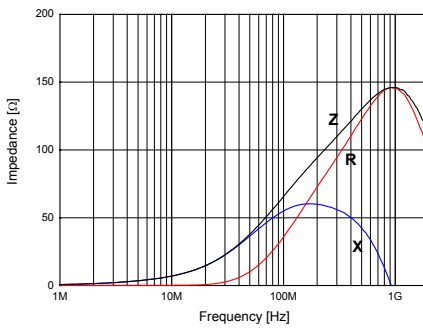

HB-1M1608-800J

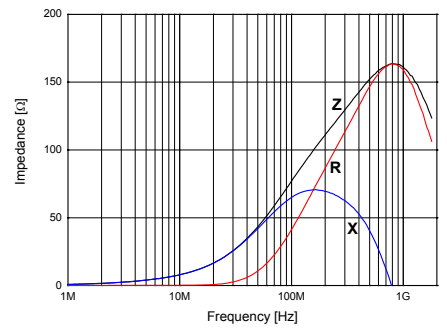

HB-1M1608-121J

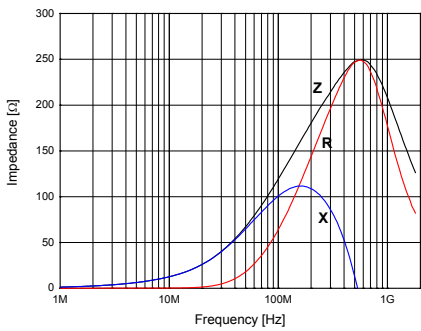

HB-1M1608-221J

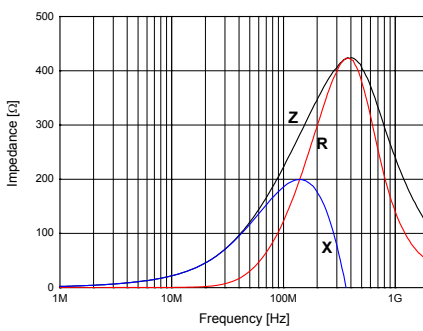

HB-1M1608-301J

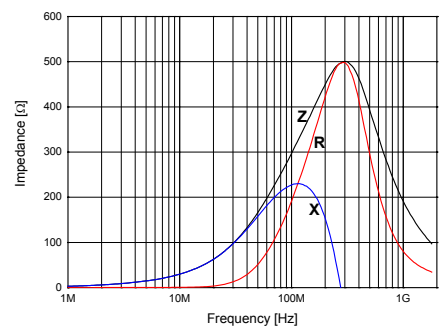

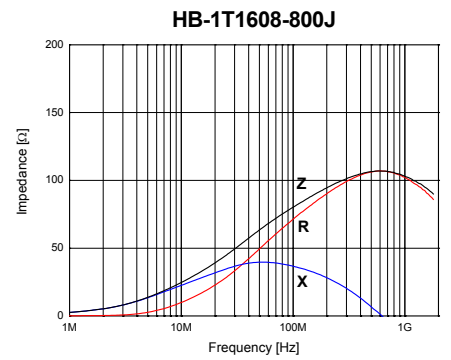
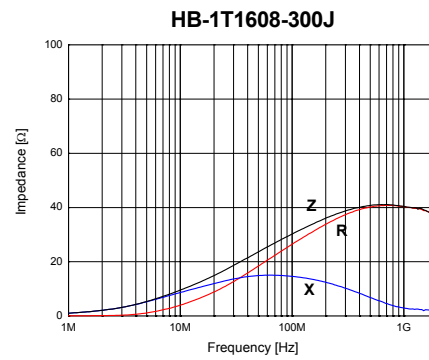
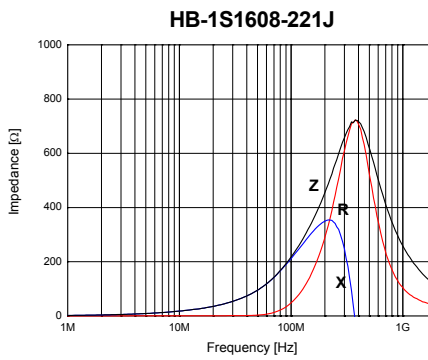
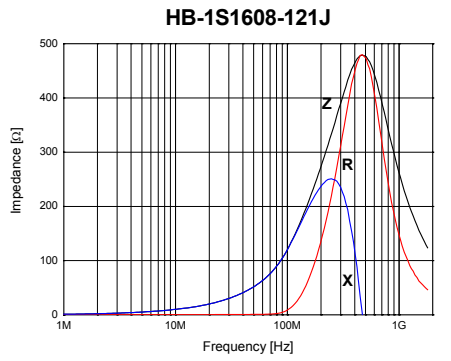
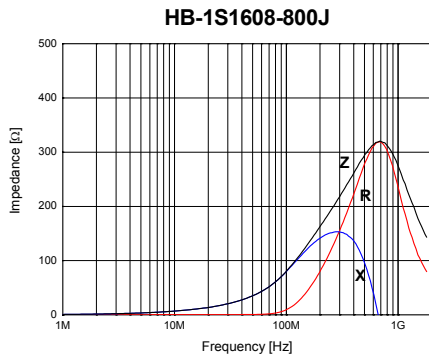
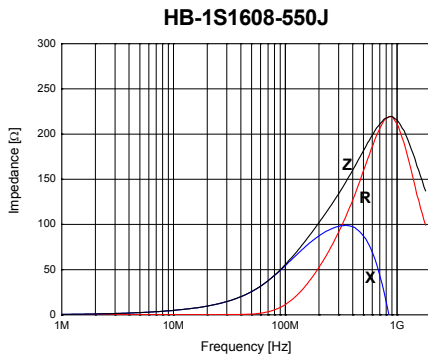
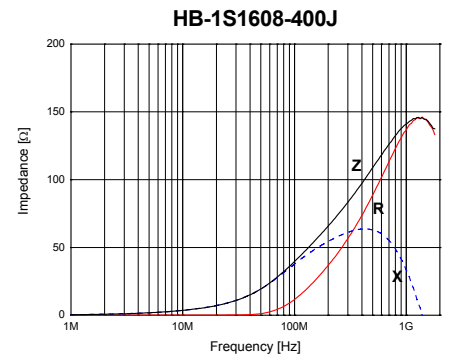
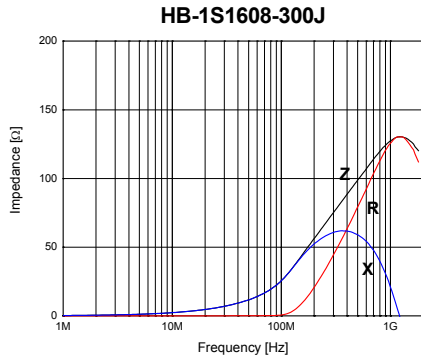
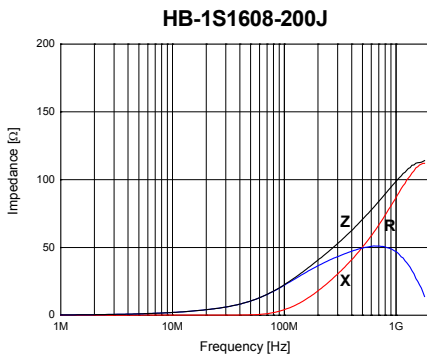
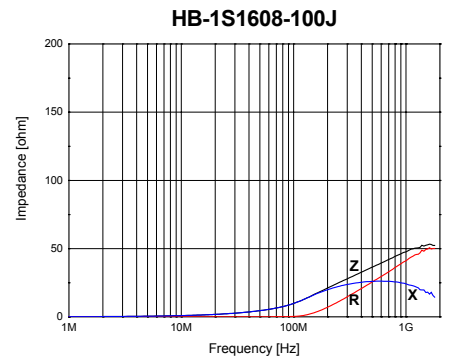
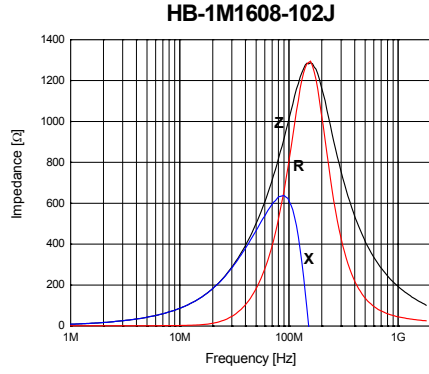
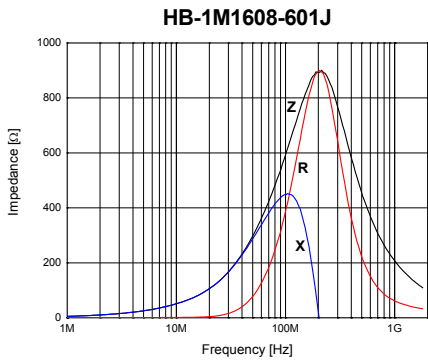

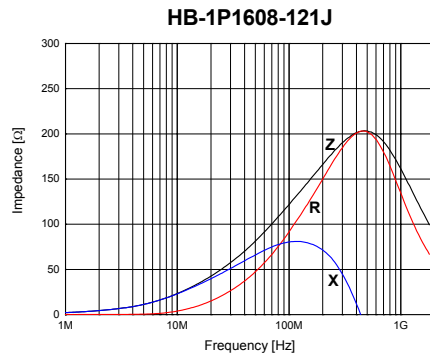
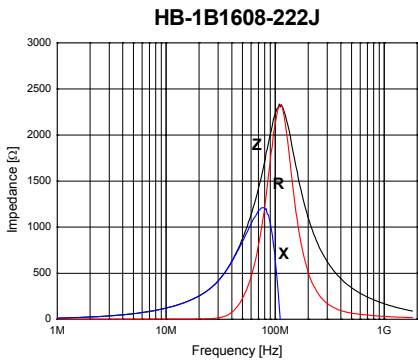
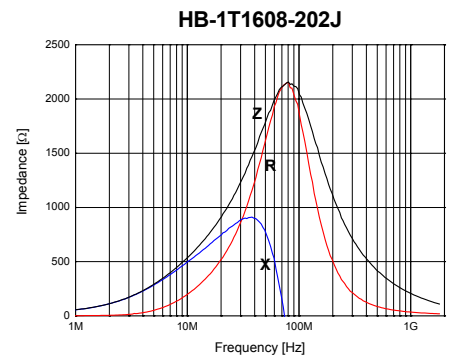
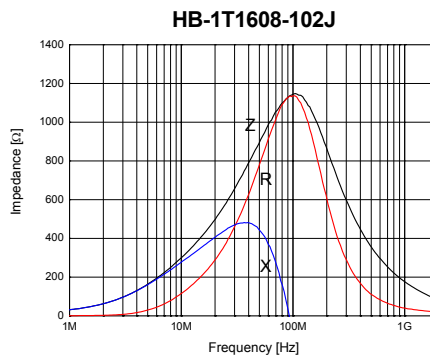
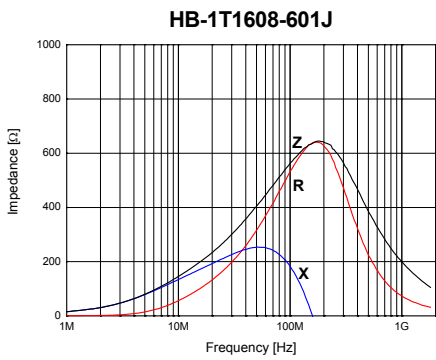
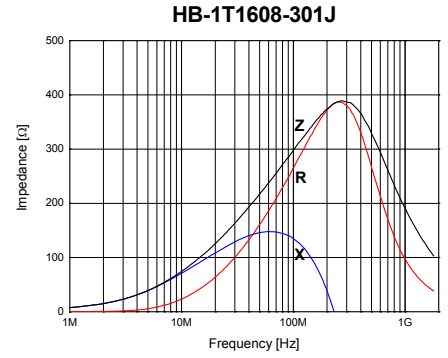
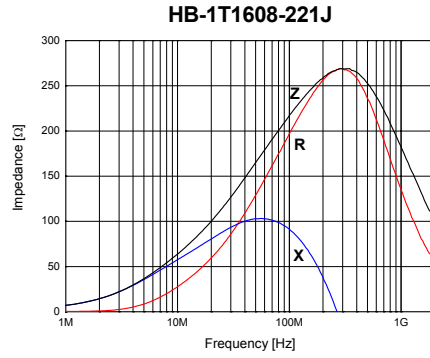
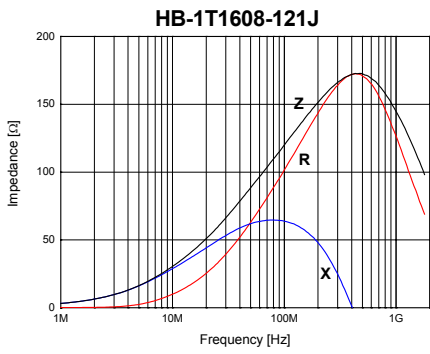

■ HB2012

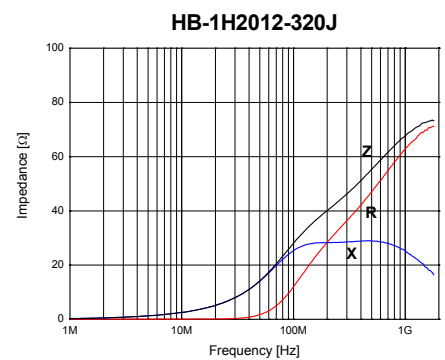
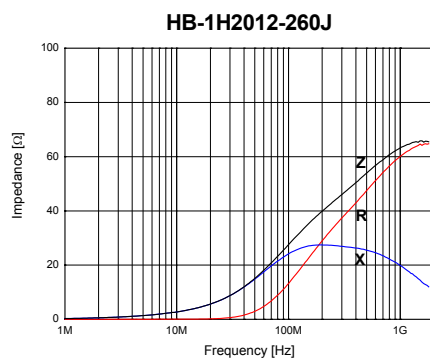
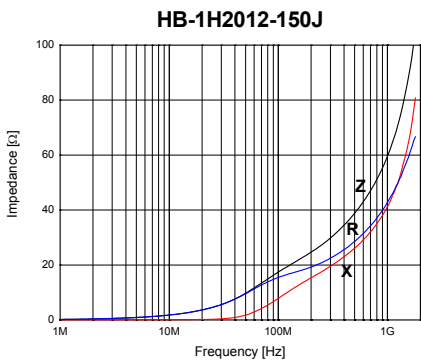

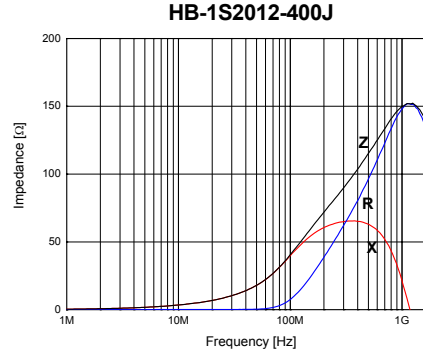
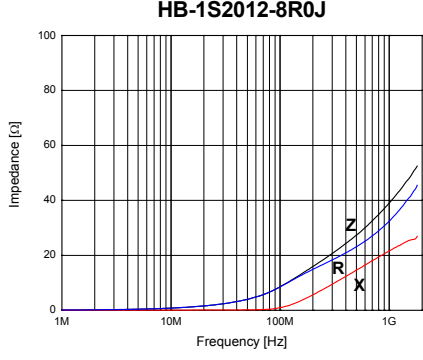
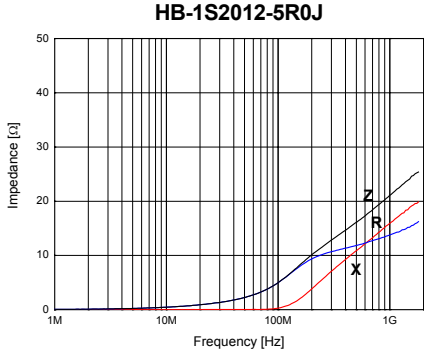
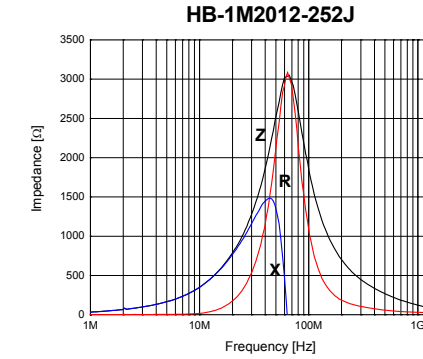
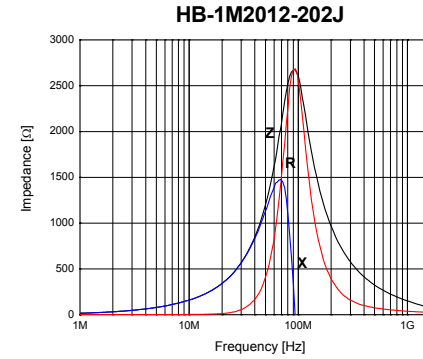
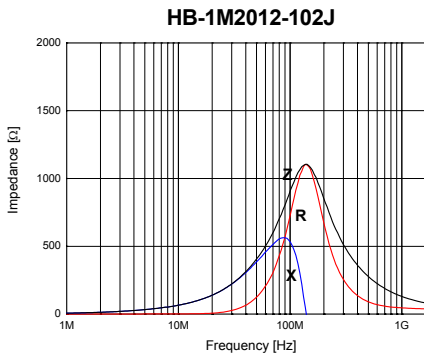
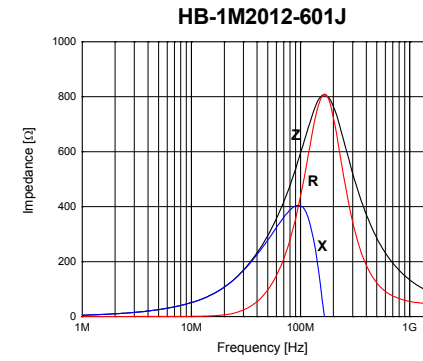
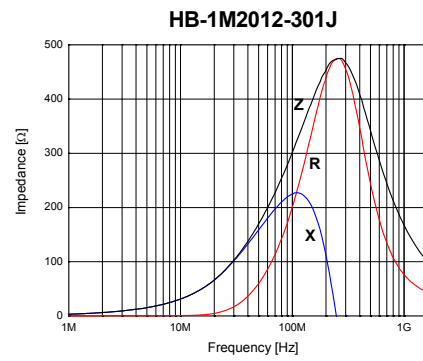
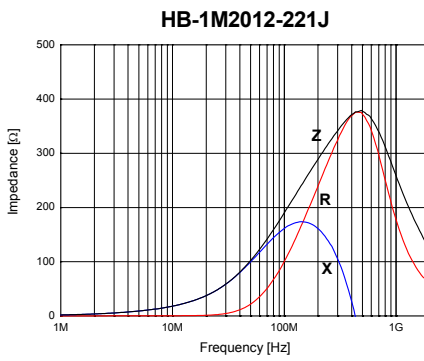
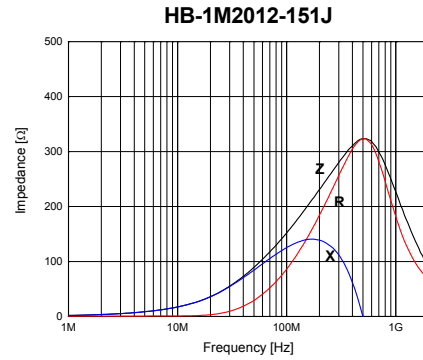
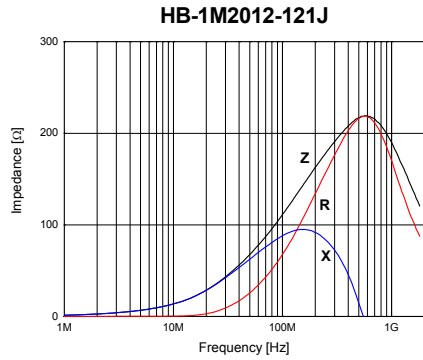
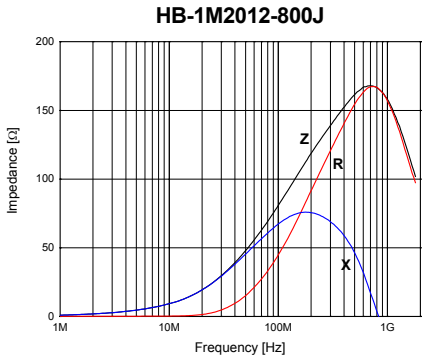

HB-1S2012-800J

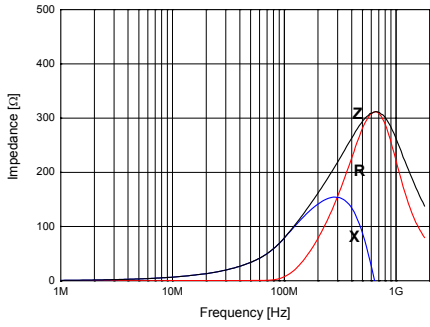

HB-1S2012-121J

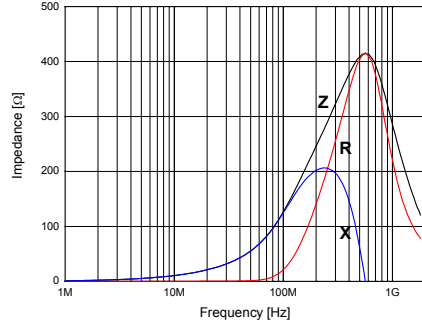

HB-1S2012-221J

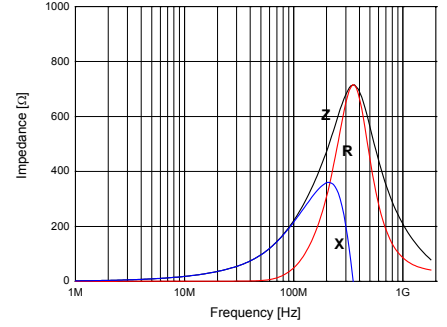

HB-1T2012-400J

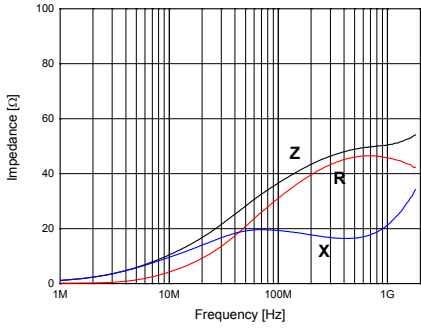

HB-1T2012-800J

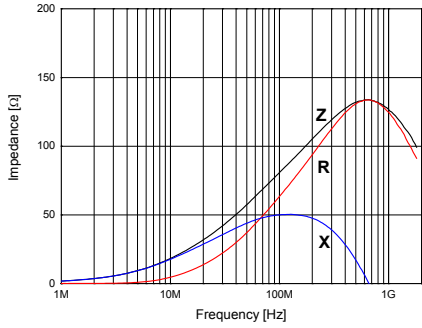

HB-1T2012-121J

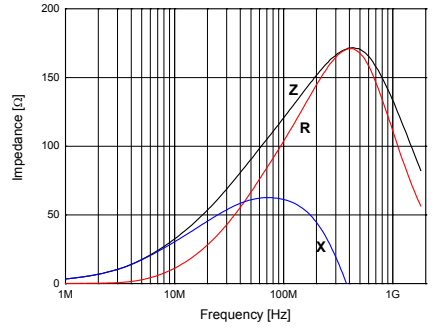

HB-1T2012-221J

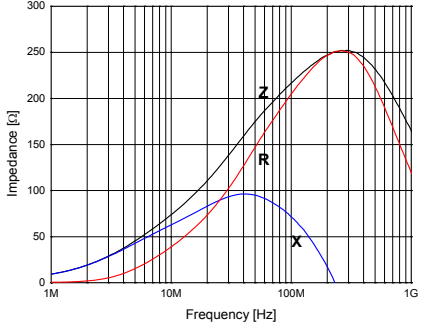

HB-1T2012-301J

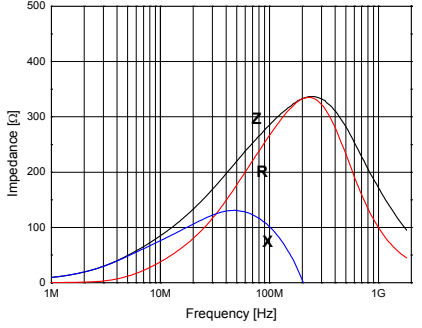

HB-1T2012-331J

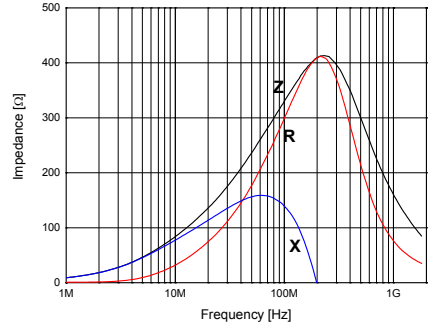

HB-1T2012-601J

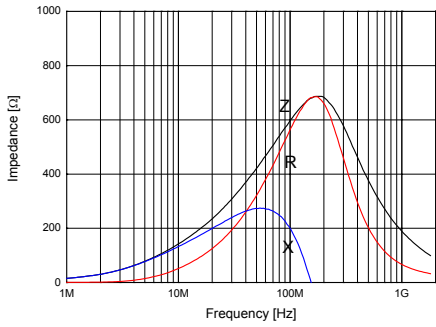

HB-1T2012-102J

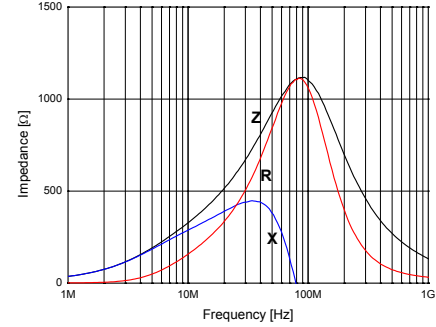

HB-1T2012-202J

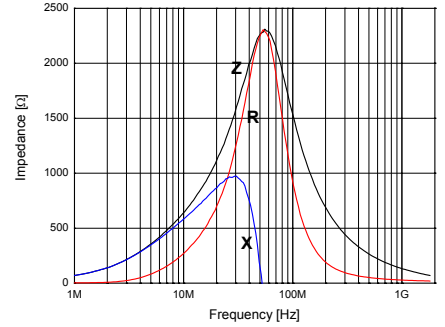

HB-1T2012-252J

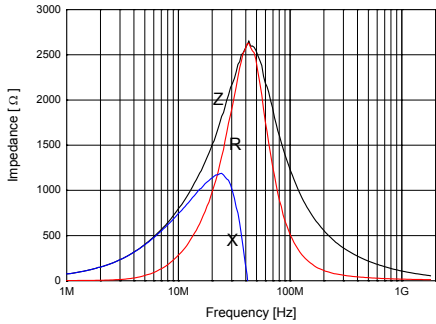

HB-1B2012-222J

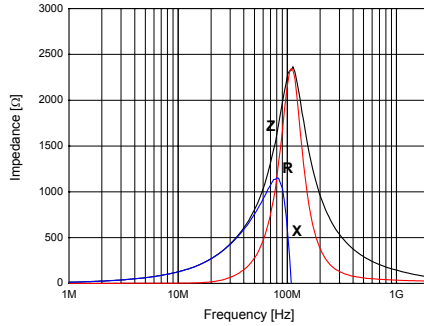

HB-1B2012-272J

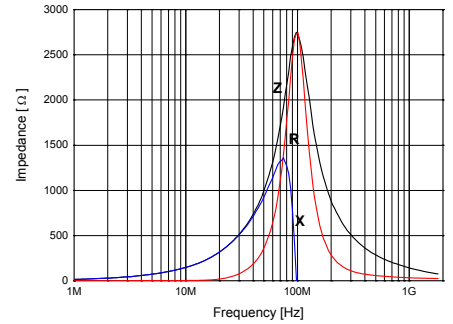

■ HB3216

HB-1H3216-500J

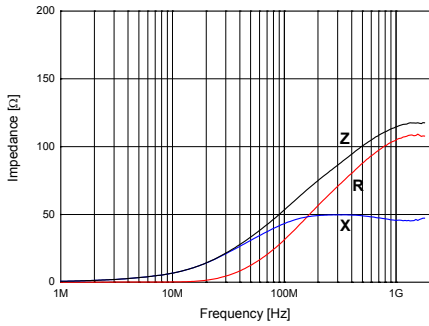

HB-1H3216-700J

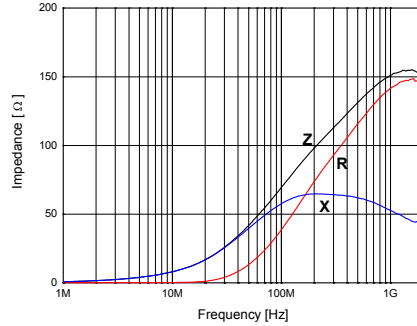

HB-1M3216-121J

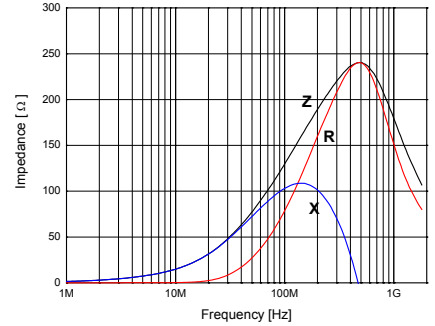

HB-1M3216-151J

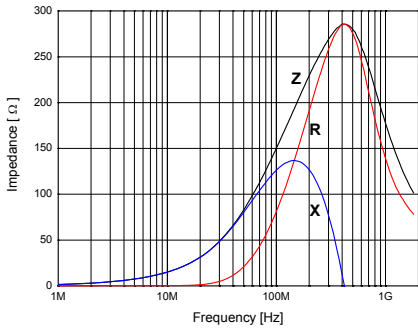

HB-1M3216-201J

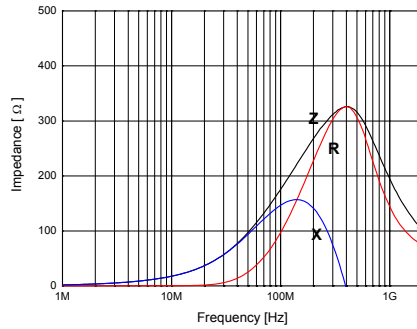

HB-1M3216-301J

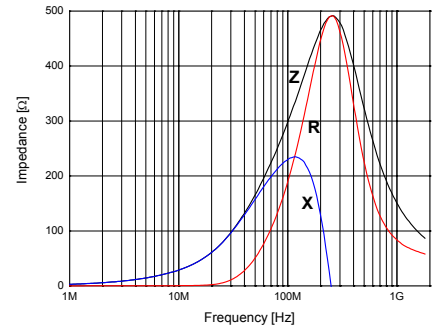

HB-1M3216-601J

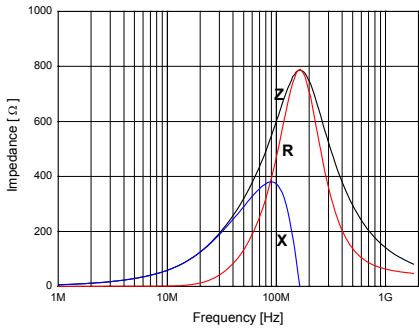

HB-1M3216-102J

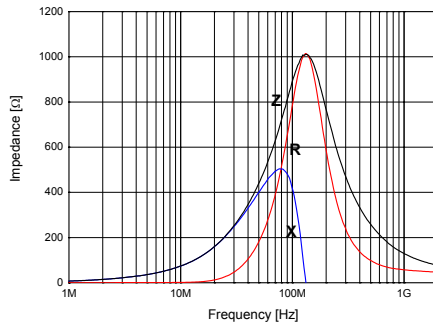

HB-1S3216-200J

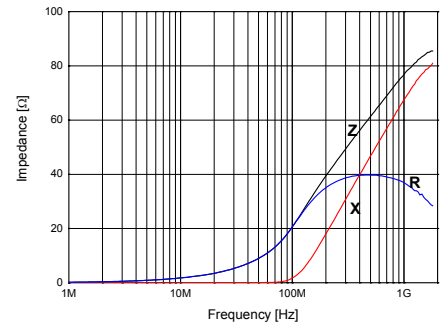

HB-1S3216-251J

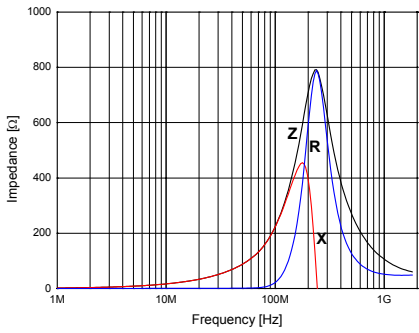

HB-1T3216-350J

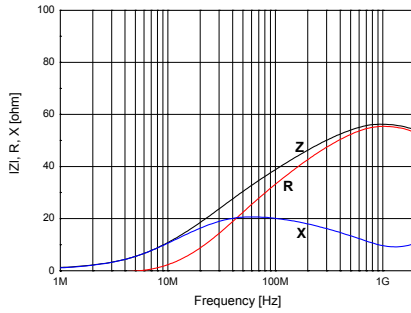

HB-1T3216-500J

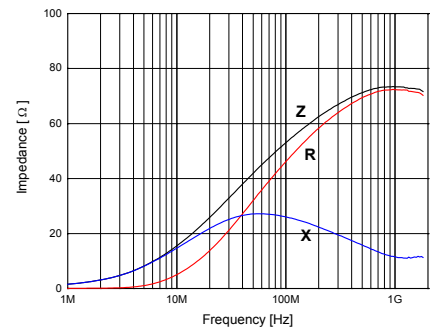

HB-1T3216-700J

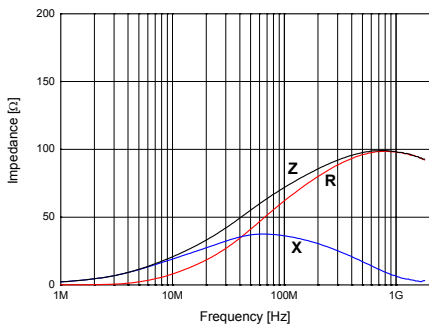

HB-1T3216-121J

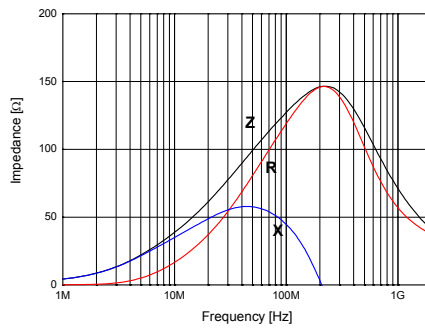

HB-1T3216-151J

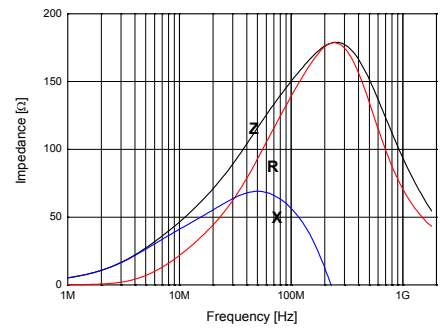

HB-1T3216-201J

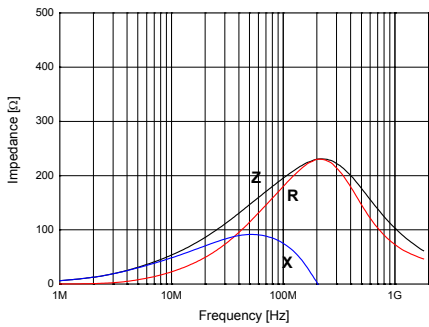

HB-1T3216-601J

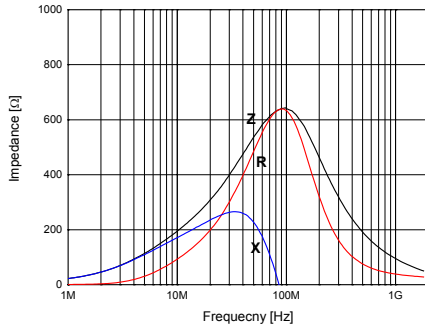

HB-1T3216-801J

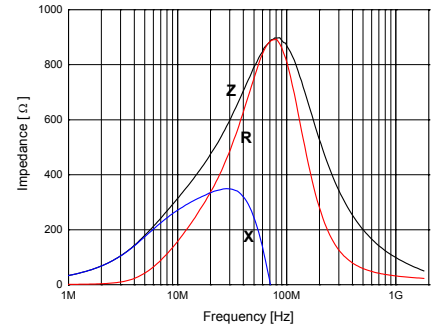

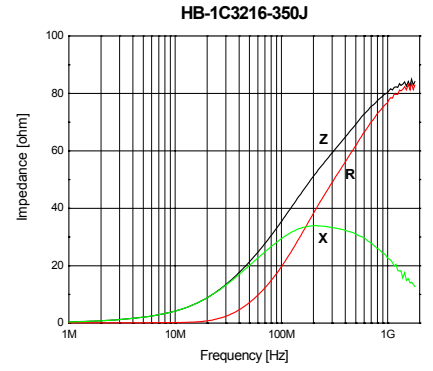
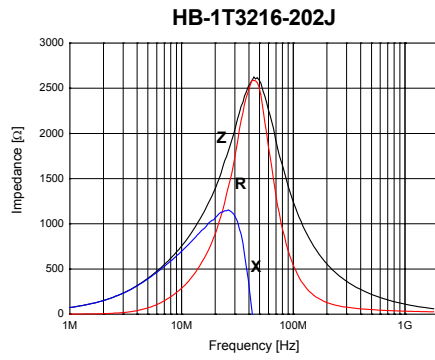
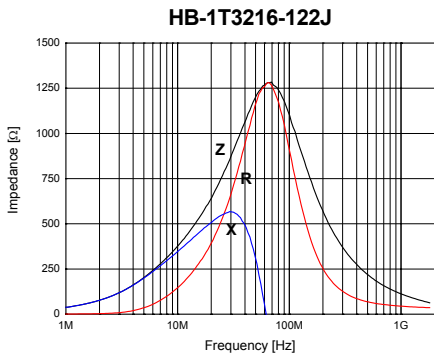

■ HB4516

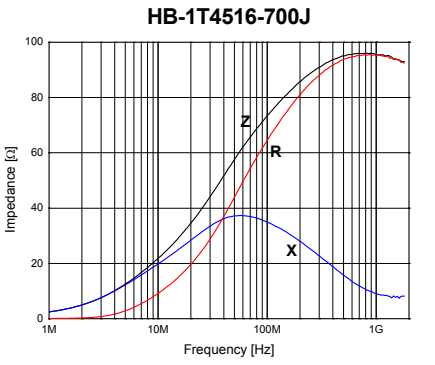
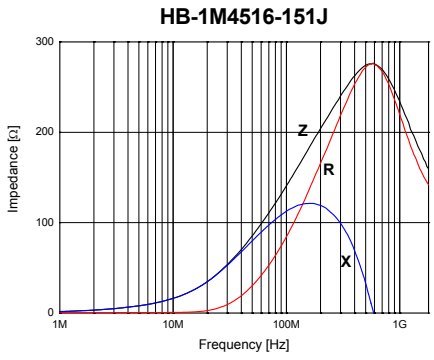

■ HB4532

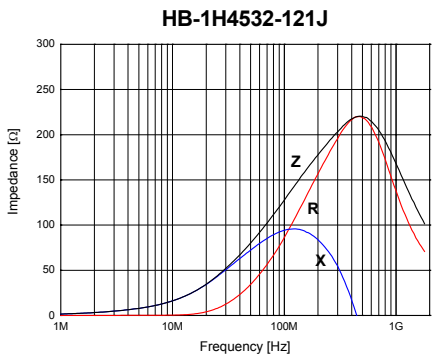

■ HB SERIES - L TYPE (For ultra high frequency signal line)

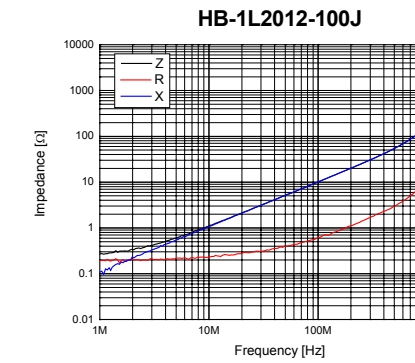
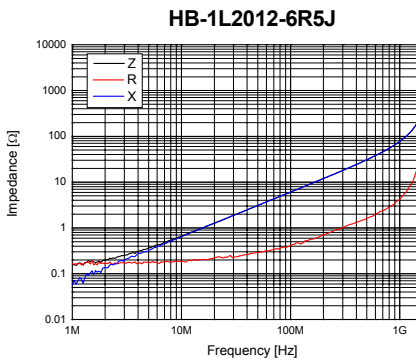
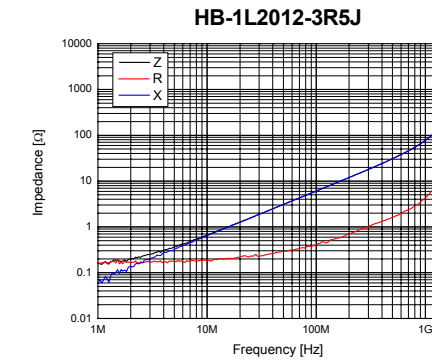
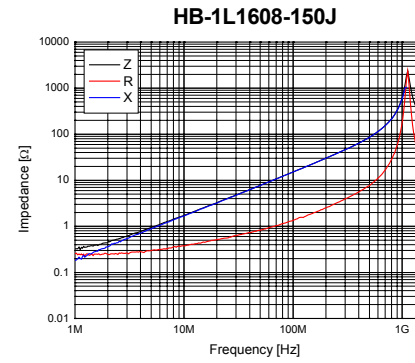
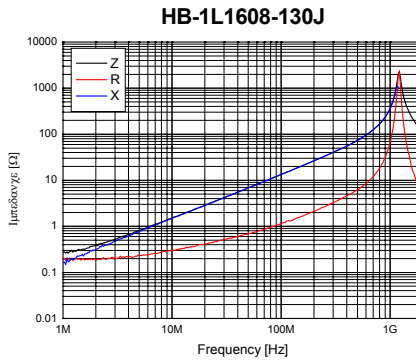
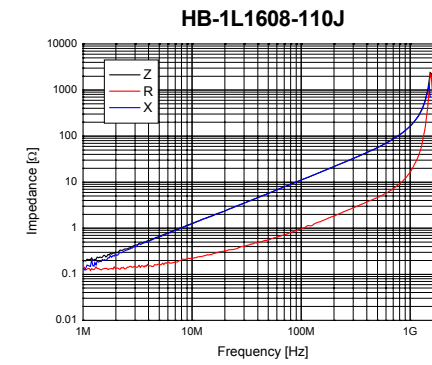
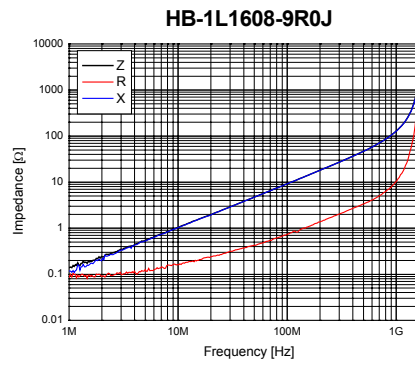
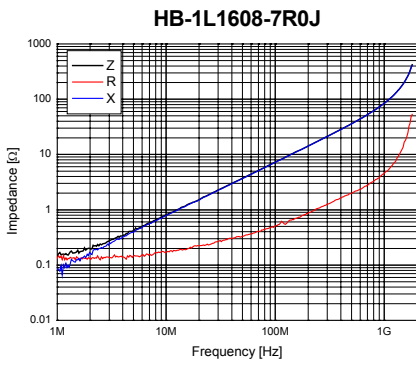
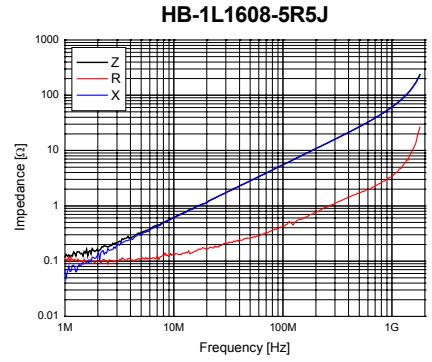
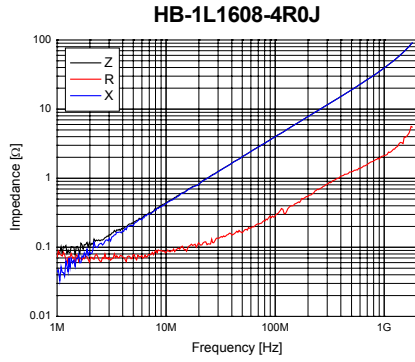
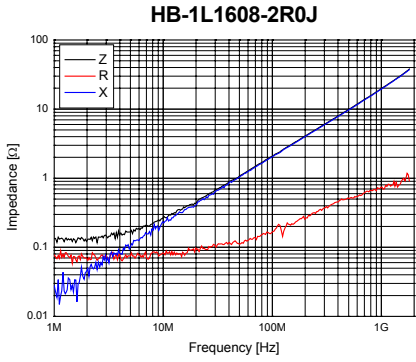

■ HB SERIES - Y TYPE (For ultra high frequency signal line)

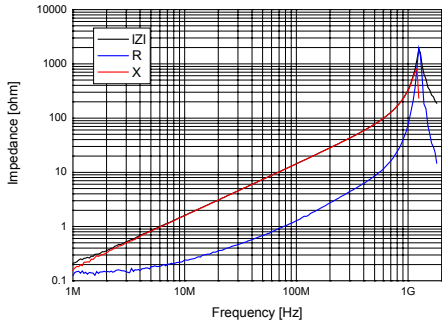
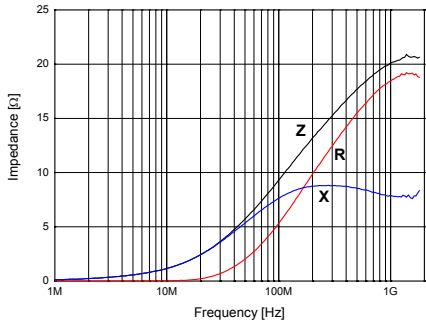
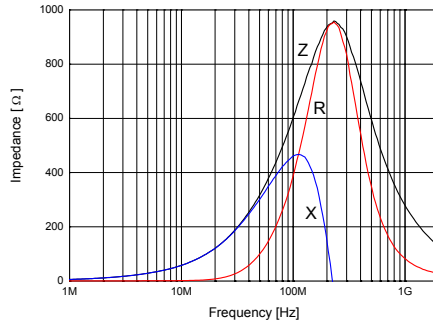
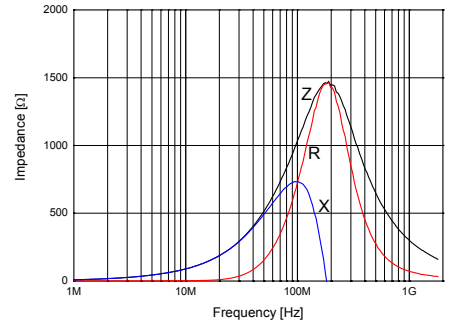
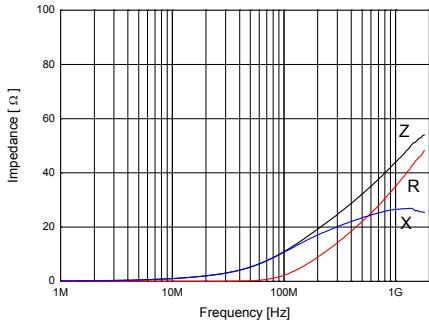
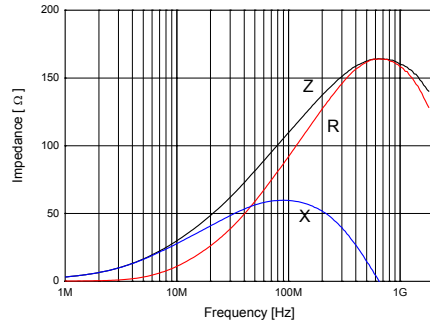
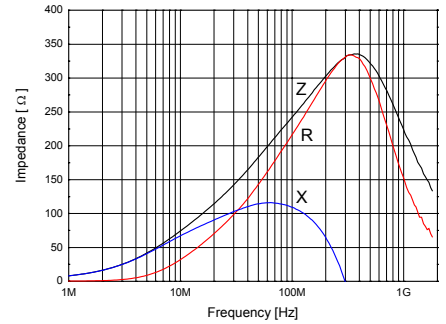
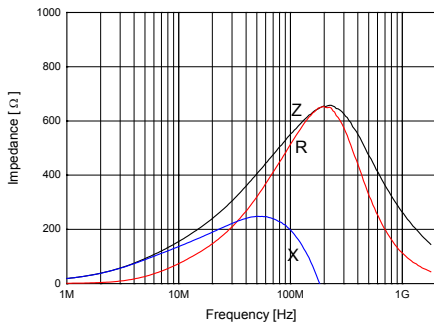
HB-1Y1608-150J

HH1005
HH-1H1005-100J

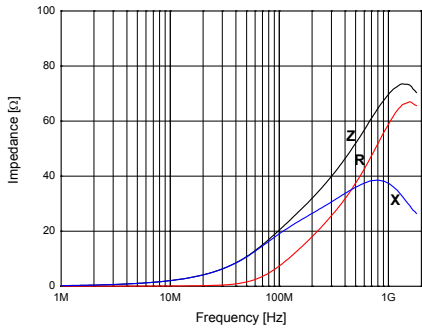
HH-1M1005-601J

HH-1M1005-102J

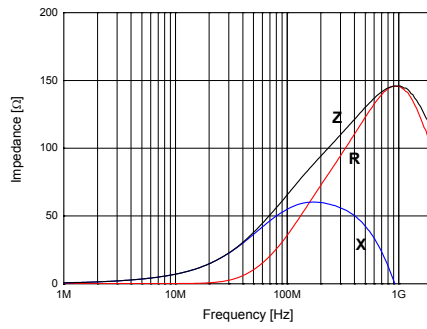
HH-1S1005-100J

HH-1T1005-121J

HH-1T1005-241J

HH-1T1005-601J

HH1608

HH-1H1608-300J



HH-1M1608-600J



HH-1M1608-121J

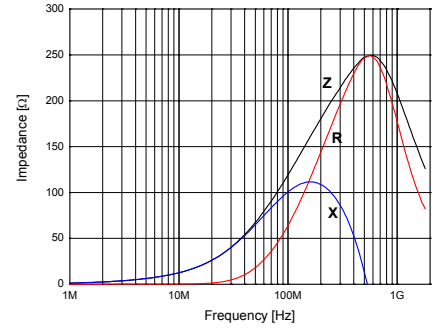

HH-1M1608-221J

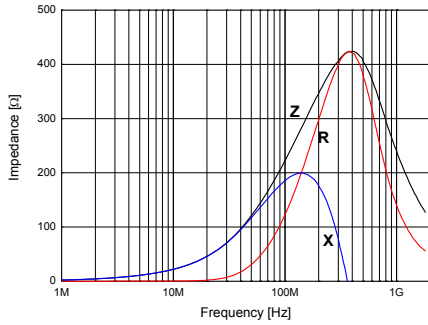

HH-1M1608-301J

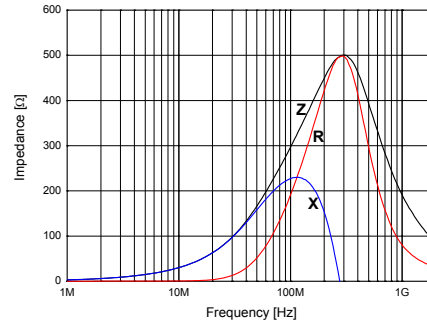

HH-1M1608-601J

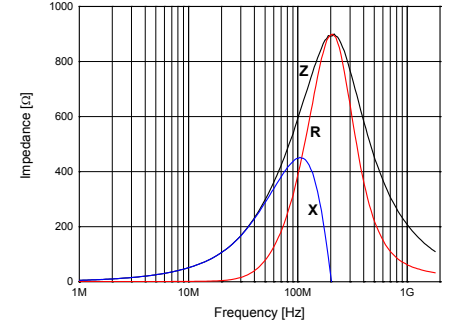

HH-1M1608-102J

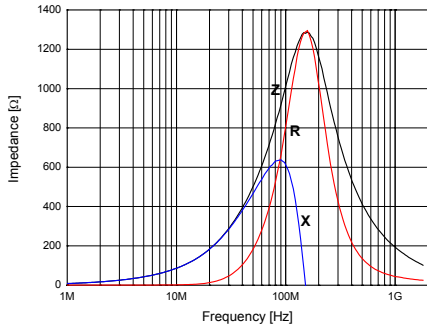

HH-1S1608-100J

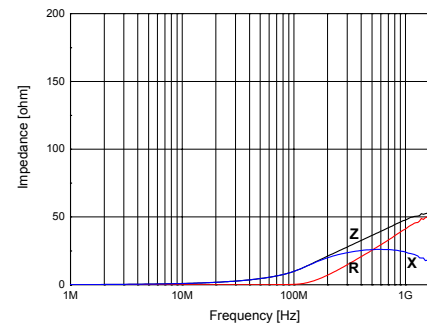

HH-1S1608-200J

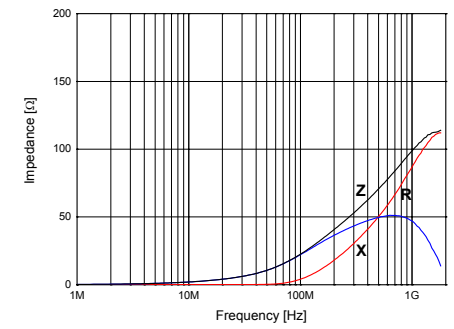

HH-1S1608-300J

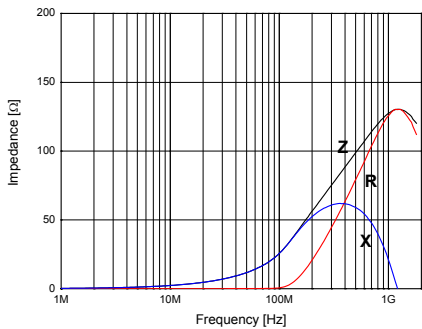

HH-1S1608-400J

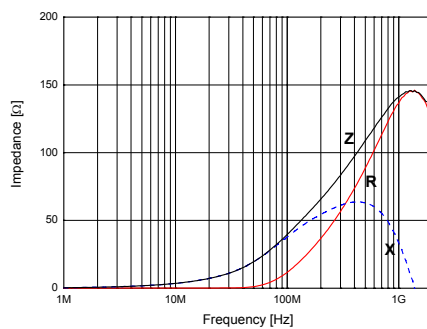

HH-1S1608-550J

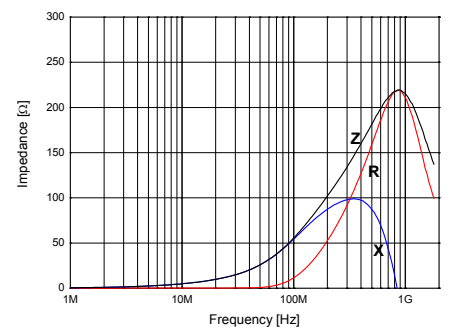

HH-1S1608-800J

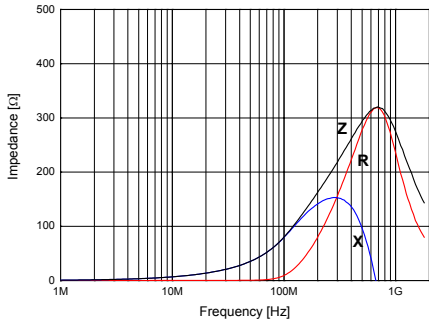

HH-1S1608-121J

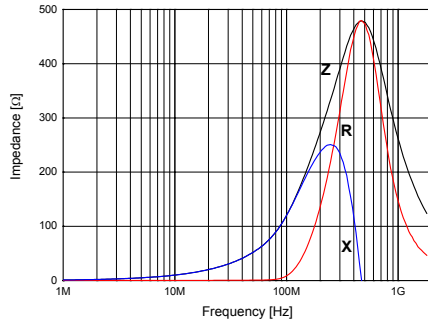

HH-1S1608-221J

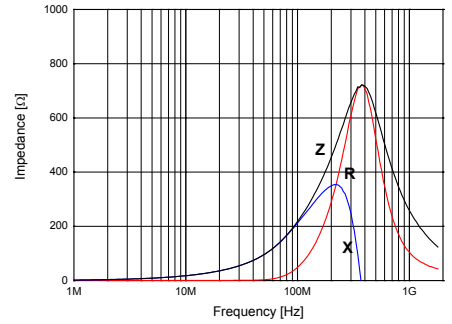

HH-1T1608-300J

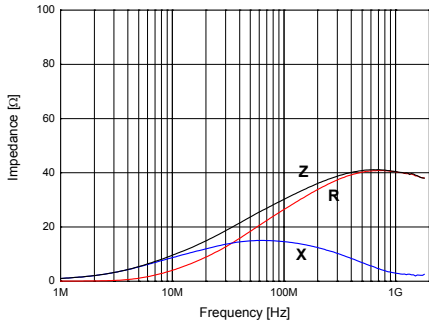

HH-1T1608-800J

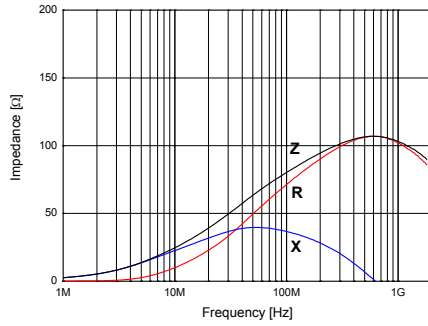

HH-1T1608-121J

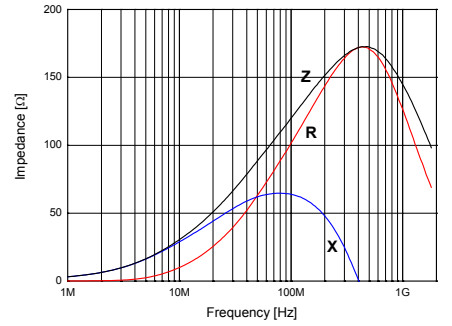

HH-1T1608-221J

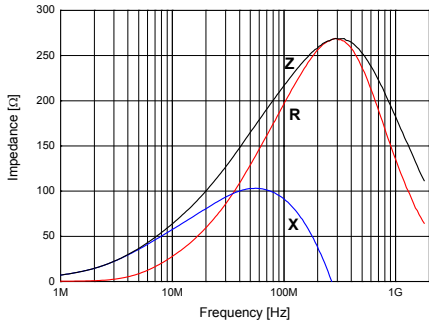

HH-1T1608-301J

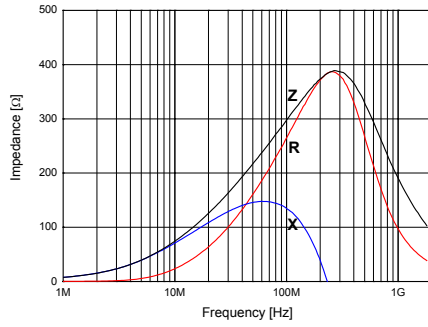

HH-1T1608-601J

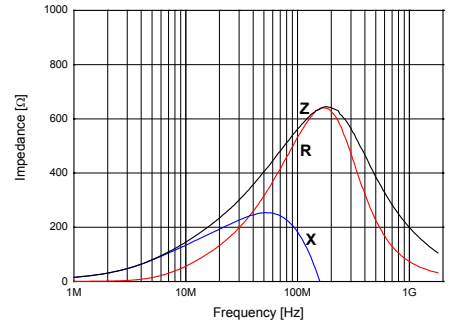

HH-1T1608-102J

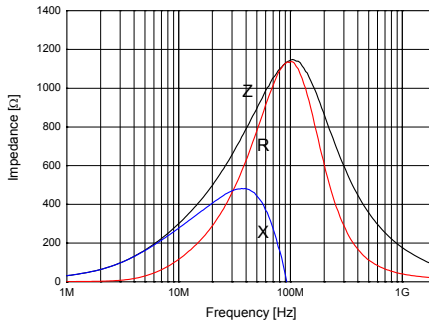

■ HH2012

HH-1H2012-150J

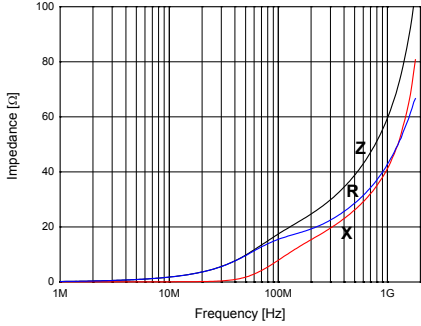

HH-1H2012-260J

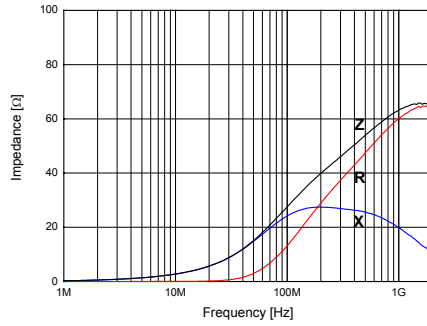

HH-1H2012-320J

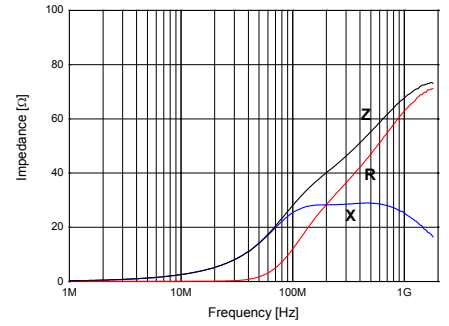

HH-1M2012-800J

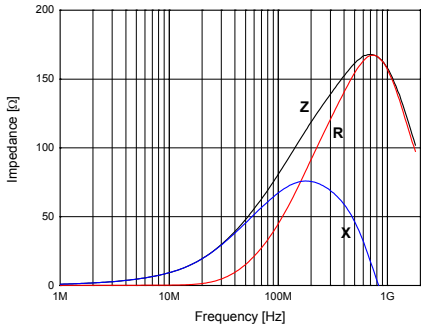

HH-1M2012-121J

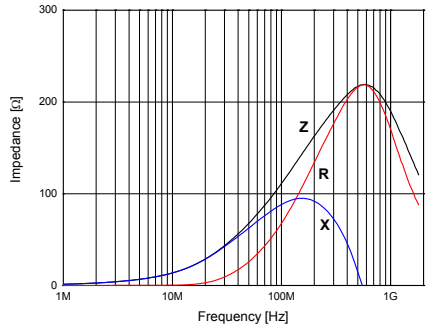

HH-1M2012-151J

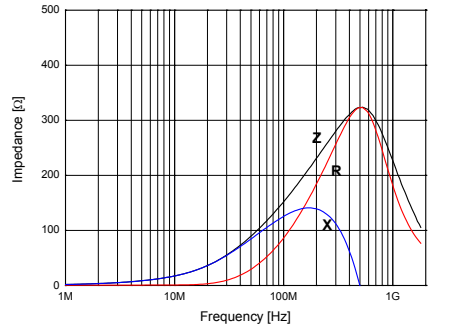

HH-1M2012-221J

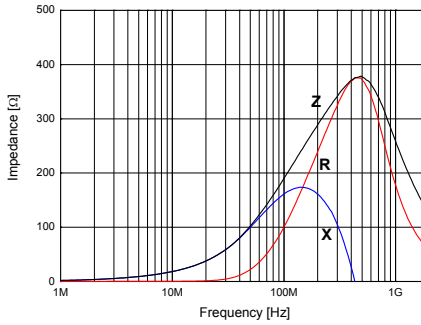

HH-1M2012-301J

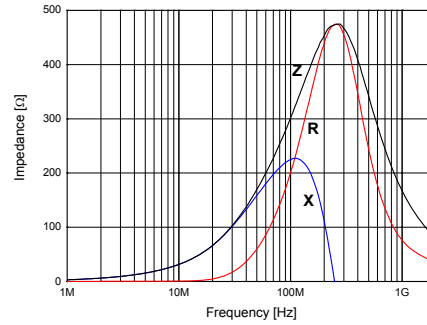

HH-1M2012-601J

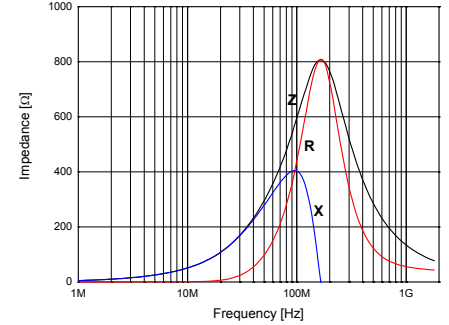

HH-1M2012-102J

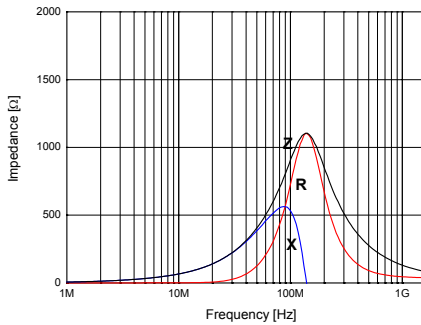

HH-1M2012-202J

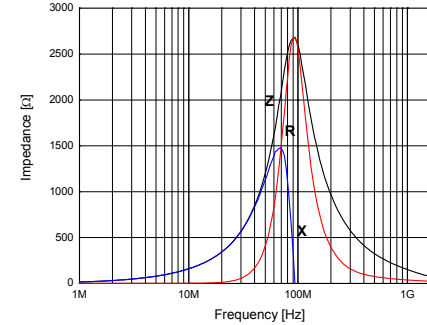

HH-1S2012-5R0J

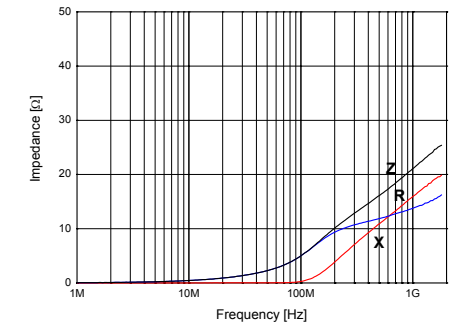

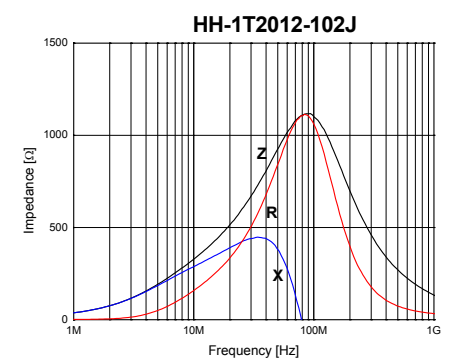
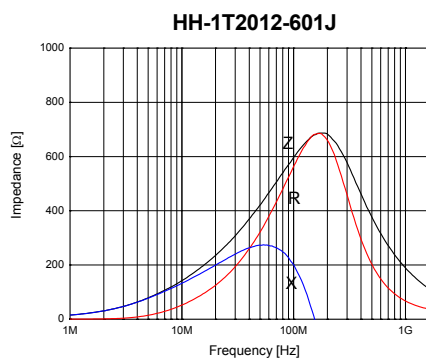
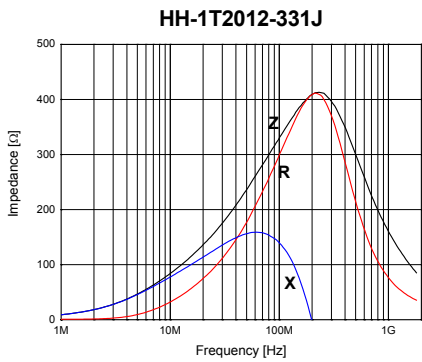
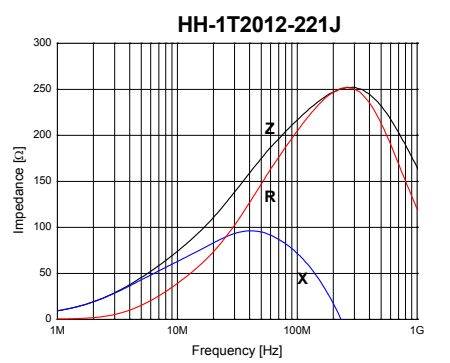
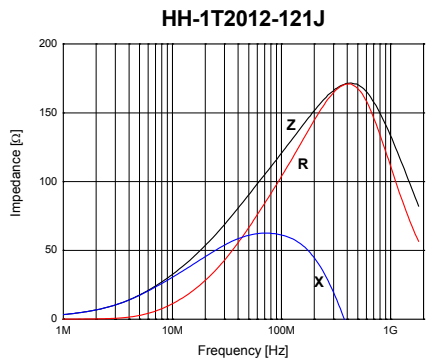
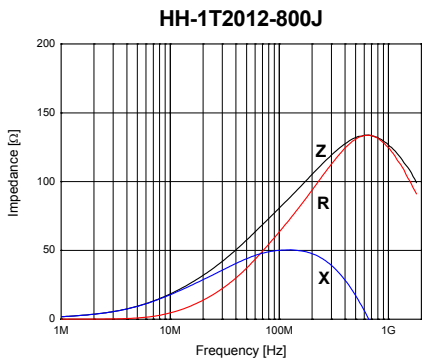
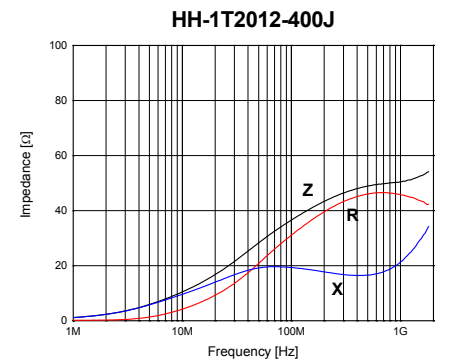
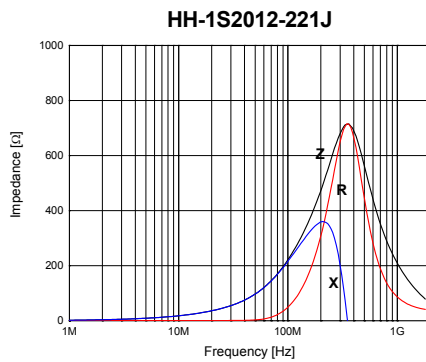
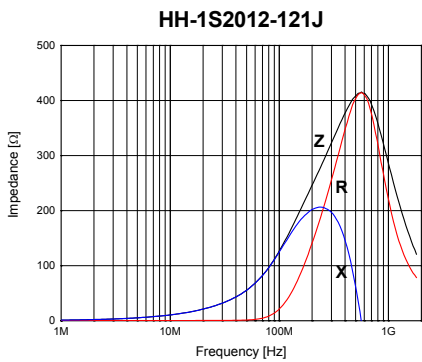
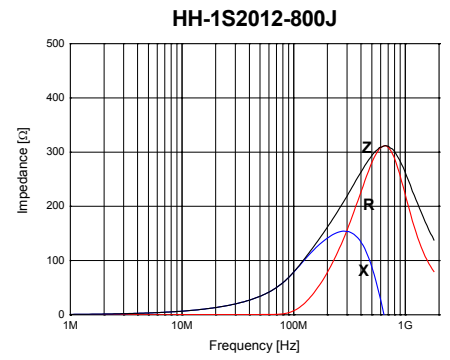
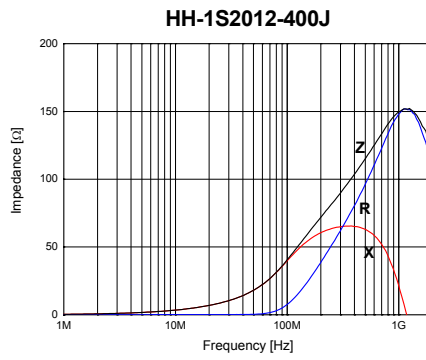
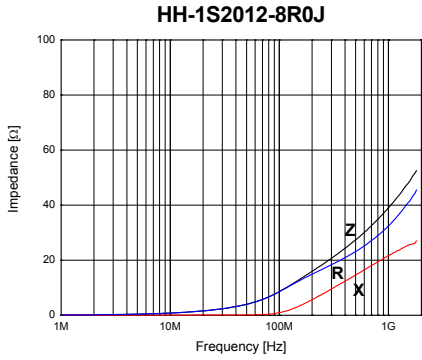

■ HH3216

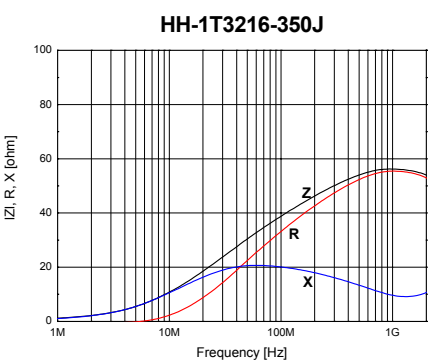
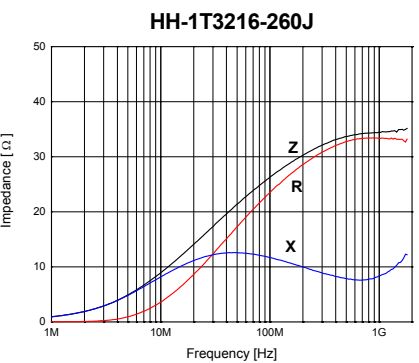
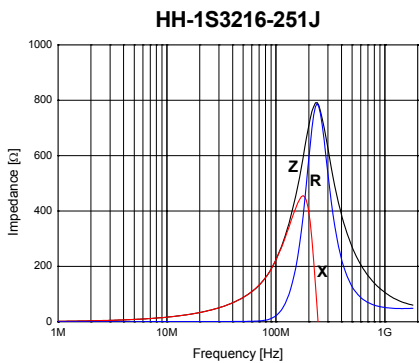
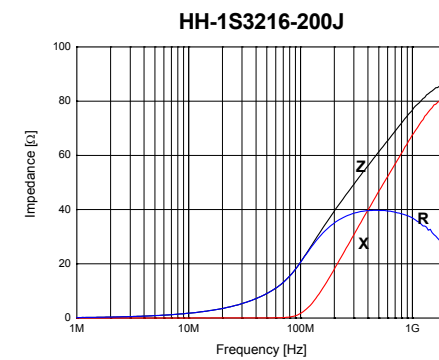
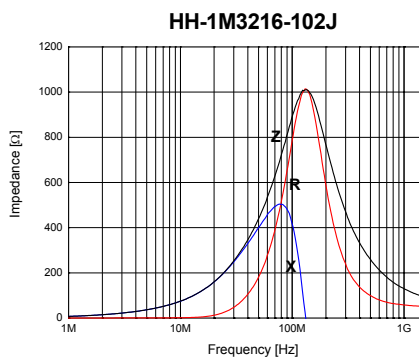
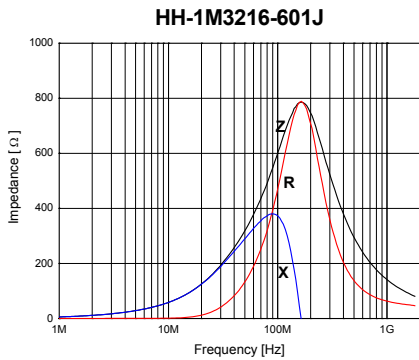
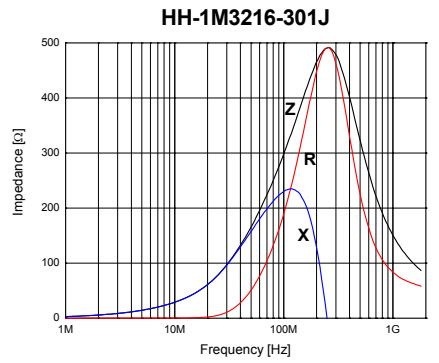
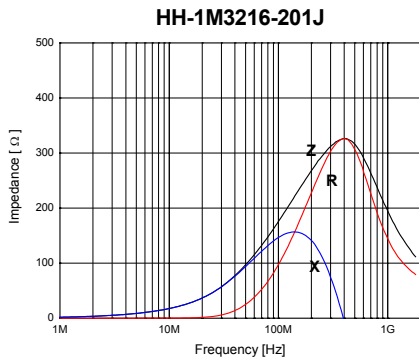
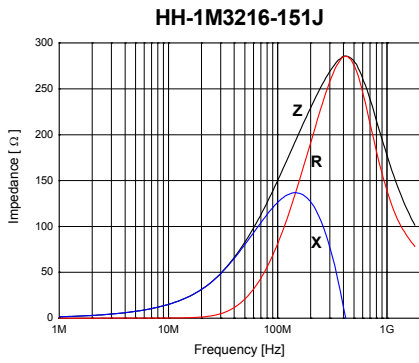
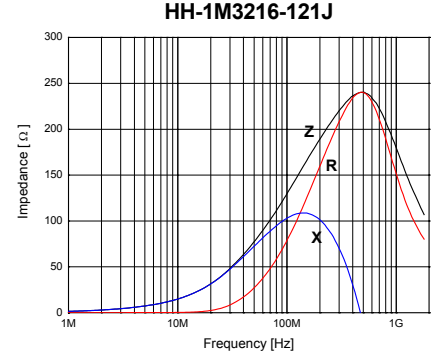
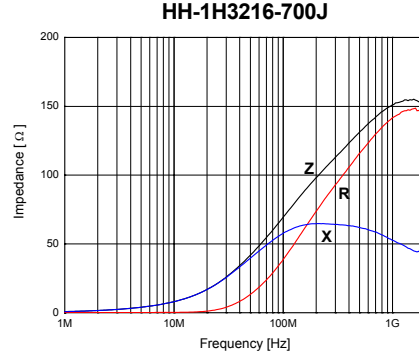
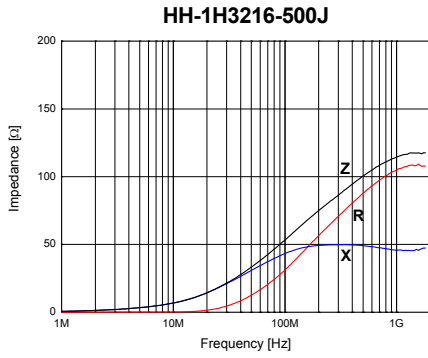

HH-1T3216-500J

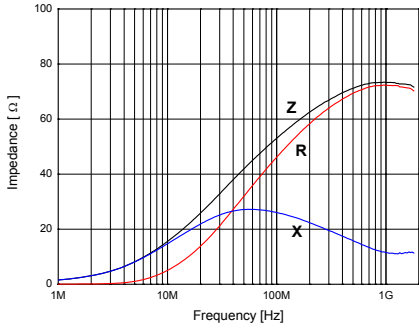

HH-1T3216-700J

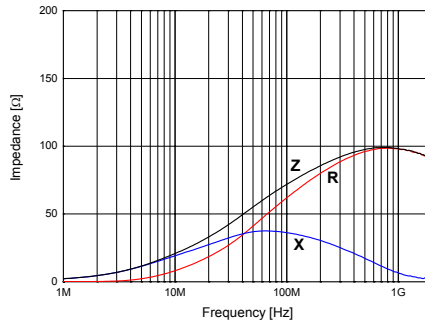

HH-1T3216-121J

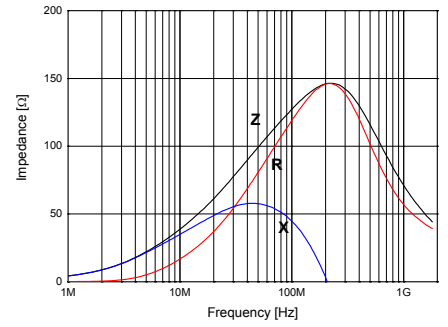

HH-1T3216-151J

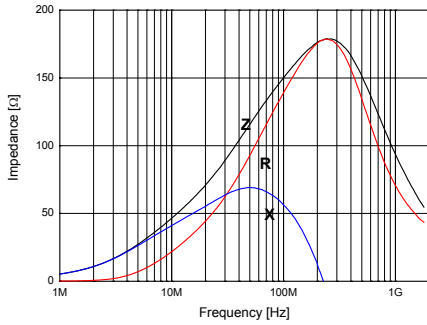

HH-1T3216-201J

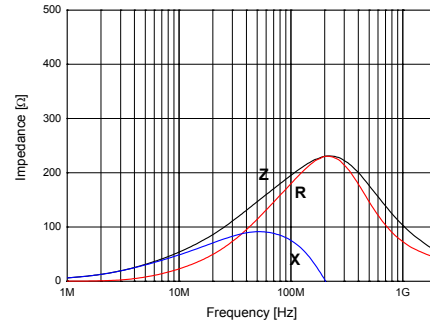

HH-1T3216-601J

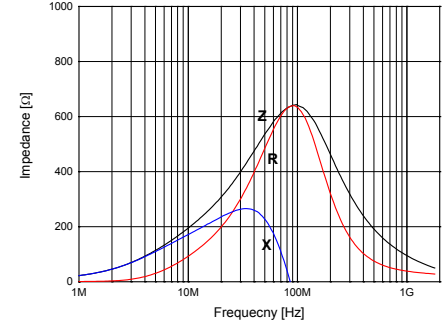

HH-1T3216-801J

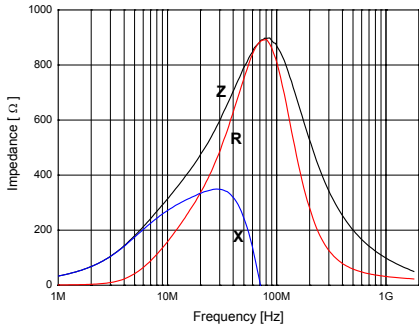

HH-1T3216-202J

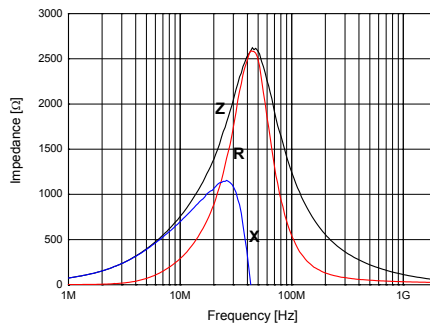

■ **HH4516**

HH-1H4516-600J

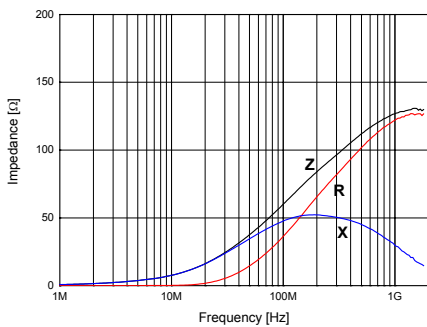

■ HH4532

HH-1H4532-121J

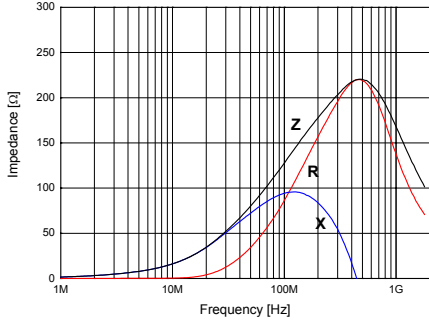

HH-1T4532-121J

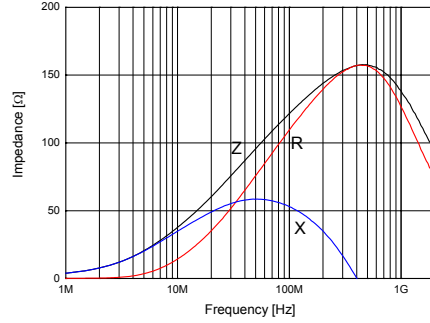

HH-1M4532-601J

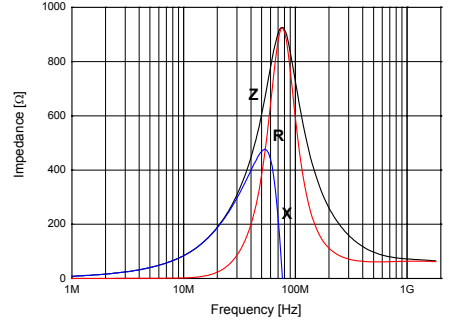

HH-1M4532-132J

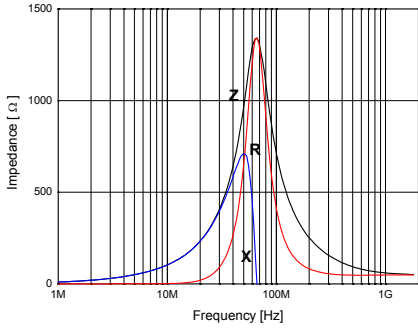

HH-1B4532-132J

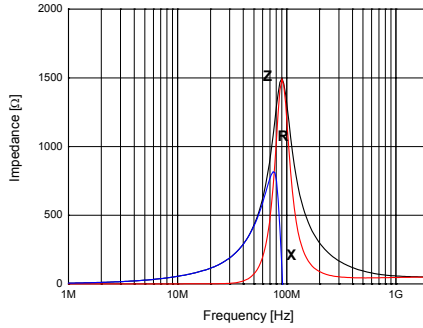

■ HH5750

HH-1M5750-401J

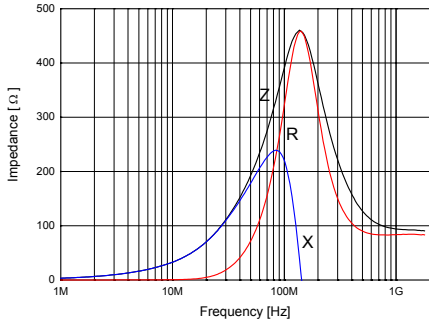

HH-1M5750-501J

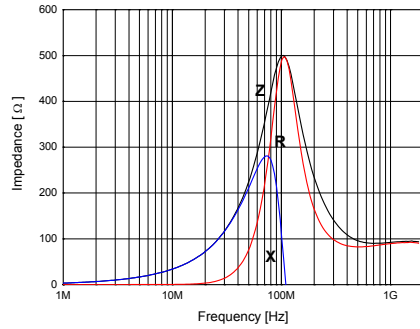

■ HU SERIES (For ultra high current)

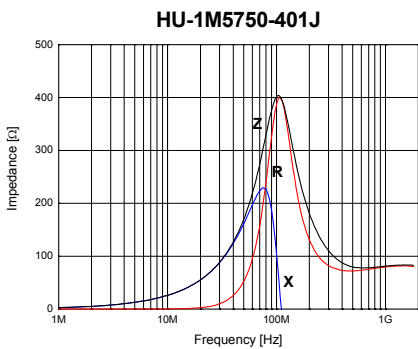
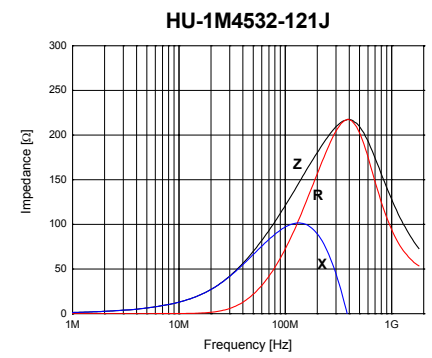
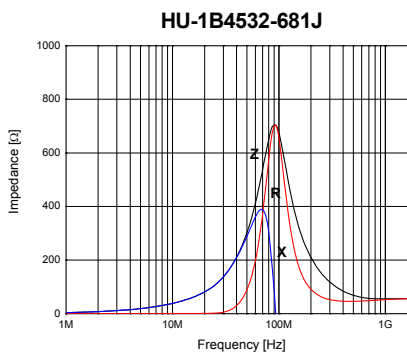
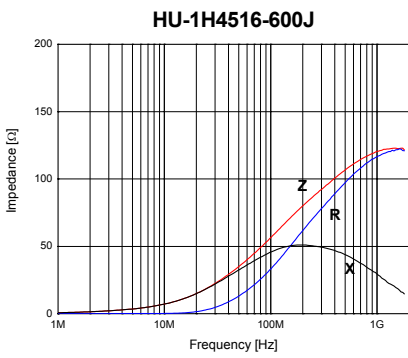
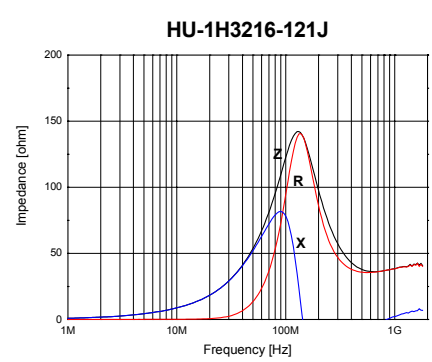
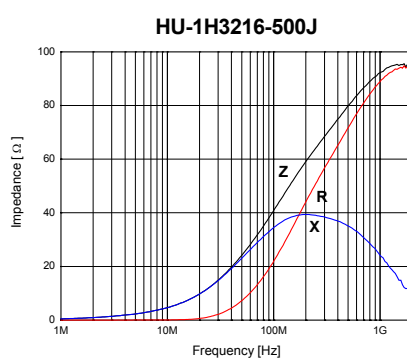
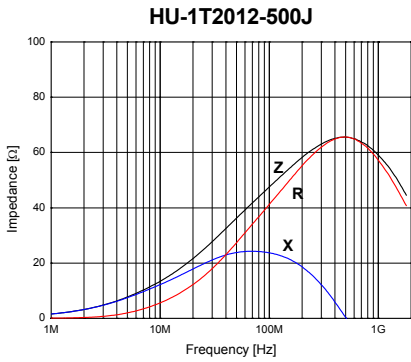
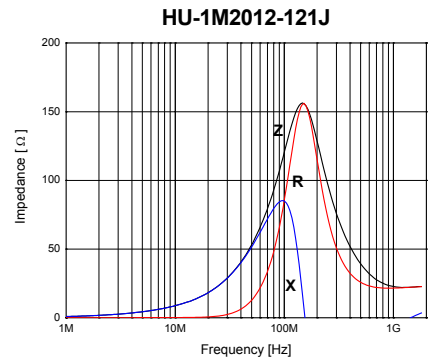
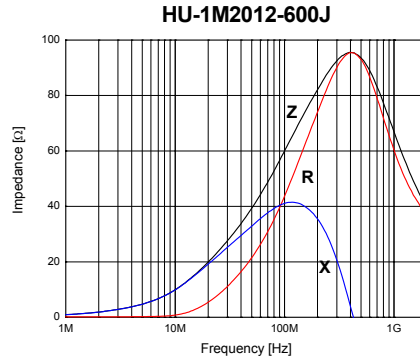
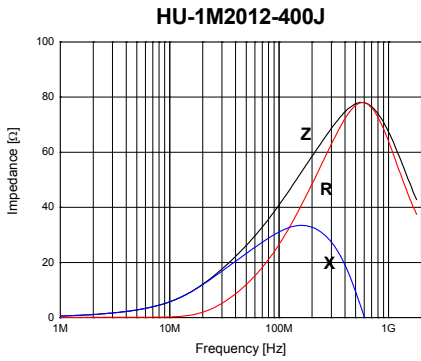

RELIABILITY AND TEST CONDITIONS

CHIP FERRITE BEADS

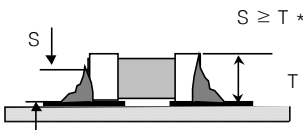
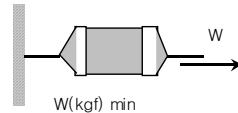
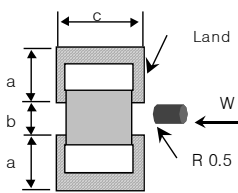
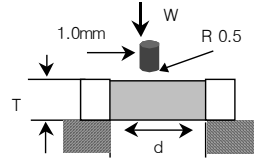
ITEM	REQUIREMENTS							TEST CONDITION
	1005	1608	2012	3216	4516	4532	5750	
Operating temp. range	-55℃~+125℃							-
Storage temp. & humidity range	40℃ max. , 70% RH max.							at packing condition
Resistance to solder heat	1.No damage such as cracks should be caused in chip element. 2.More than 75% of the terminal electrode shall be covered with new solder. 3.Impedance change : ±within 30%							Preheat temperature : 100 to 150℃ Preheat time : 1min Solder temperature : 260 ±10℃ Dipping time : 10 ±0.5sec.
Solderability	1.More than 90% of the terminal electrode shall be covered with new solder. 2. Impedance change : ±within 30%							Preheat temperature : 100 to 150℃ Preheat time : 1min Solder temperature : 230 ±10℃ Dipping time : 3 ±1sec.
Reflow soldering	1.More than 50% of the terminal electrode shall be covered with new solder. 							Preheat temperature : 150℃ Preheat time : 1min Solder temperature : 230℃ Soldering time : 10 sec. Max. (Reflow soldering profile)
Tensile strength (Terminal strength)	1.No mechanical damage <div style="text-align: right;">Unit : Kgf(W)</div>							
	W	-	1.0	2.0	2.5	2.5	3.0	3.0
Adhesion of Terminal electrode (Flexure strength)	1.No mechanical damage <div style="text-align: right;">Unit : mm (a,b,c), Kgf(W)</div>							
	a	0.7	1.0	1.0	1.3	1.5	1.5	1.8
	b	0.5	0.8	1.0	1.5	3.6	3.6	4.6
	c	0.7	1.3	1.3	3.0	3.0	3.8	5.8
	W	0.7	2.0	4.0	5.0	5.0	5.0	5.0
Body strength (Bending strength)	1.The body shall not be damaged by forces applied on the right. <div style="text-align: right;">Unit : mm (d), Kgf(W)</div>							
	d	-	1.3	1.3	2.0	3.0	3.8	4.8
	W	-	2.0	3.0	4.0	4.0	5.0	5.0

CHIP FERRITE BEADS

ITEM	REQUIREMENTS						TEST CONDITION
	1005	1608	2012	3216	4516	4532	
Drop	1.No mechanical damage						Drop 10 times on a concrete Floor from a height of 91cm
Vibration	1.No mechanical damage						Frequency : 10~55~10Hz Amplitude : 1.52mm Direction and time : X,Y,Z directions for 2 hours
Thermal shock (Temperature cycle)	1.No mechanical damage 2. Impedance change : \pm within 30%						Step1. $-40 \pm 3^{\circ}\text{C}$ 30 ± 3 min. Step2. $85 \pm 3^{\circ}\text{C}$ 30 ± 3 min. Number of cycle : 100 times
Heat load resistance	1.No mechanical damage 2 Impedance change : \pm within 30%						Temperature : $85 \pm 2^{\circ}\text{C}$ Applied current : rated current Time : 1,000 hours Measured at room ambient temperature after placing for 24 hours
Low temp. resistance	1.No mechanical damage 2. Impedance change : \pm within 30%						Temperature : $-40 \pm 5^{\circ}\text{C}$ Time : 1,000 hours Measured at room ambient temperature after placing for 24 hours
Humidity resistance	1.No mechanical damage 2. Impedance change : \pm within 30%						Temperature : $40 \pm 2^{\circ}\text{C}$ Humidity : 90~95% RH Time : 500 hours Measured at room ambient temperature after placing for 24 hours
Humidity load resistance	1.No mechanical damage 2. Impedance change : \pm within 30%						Temperature : $40 \pm 2^{\circ}\text{C}$ Humidity : 90~95% RH Applied current : rated current Time : 500 hours Measured at room ambient temperature after placing for 24 hours

	ITEM	PAGE
	CHIP FERRITE - BEADS	31/35

PRECAUTION FOR PRODUCT STORAGE

The electrical characteristics of products will not change when stored under typical environmental conditions. However, it is possible that the solderability of the terminal electrodes and the characteristics of the tape packaging can change during storage. For this reasons, the following storage guidelines should be followed.

1. STORAGE ENVIRONMENT

The tape packaging material is designed to withstand long-term storage, but they will degrade more rapidly in the presence of high temperature or high humidity. Therefore, the products shall be stored in an ambient temperature of less than 40°C with a relative humidity of less than 70%. The products should be used within 6 months of receipt.

To achieve best solderability, the products should be used as soon as possible after unpacking. Leftover products must be stored in dry conditions with desiccant.

2. CORROSIVE GASES

Since sulfur and chlorine may degrade the solderability of the terminal electrodes, it is important to store the products in an environment free of these gases.

3. TEMPERATURE FLUCTUATIONS

Dew condensation may occur when the product is taken out of storage due to variation of temperature. It is important to maintain a temperature-controlled environment.

PACKAGING

STANDARD QUANTITY

Type	Q`TY(PCS)	REMARKS
0603	15,000	
	10,000	
1005	50,000	BULK CASSETTE
	30,000	Φ254mm
	10,000	
1608	4,000	4mm pitch
	8,000	
2012	3,000	
	7,000	Φ254mm
3216	3,000	
	7,000	Φ254mm
4516	3,000	
4532	1,500	
5750	1,000	

REEL DIMENSION

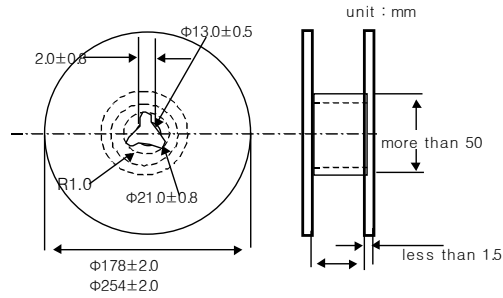

Type	W[mm]
0603, 1005, 1608, 2012	9.0 ±0.3
4516, 4532, 5750	13.0 ±0.3

TAPING DIMENSION / 8mm wide

* Embossing Tape

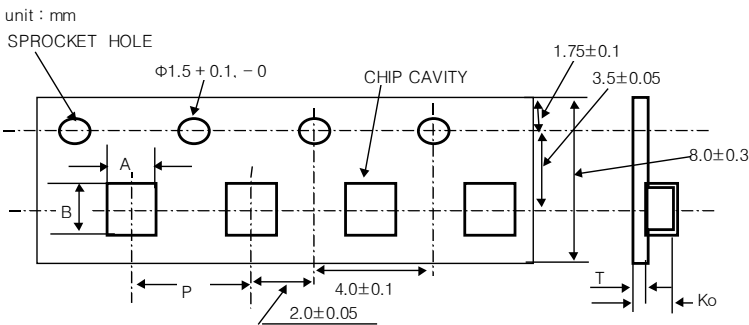

PRODUCT	Type	A ±0.1	B ±0.1	P ±0.1	Ko ±0.1	T(max.)
CHIP BEADS	1608	1.00	1.80	4.0	0.95	0.3
	2012	1.45	2.25	4.0	1.00	0.3
	3216	1.90	3.60	4.0	1.35	0.3

* Paper Tape

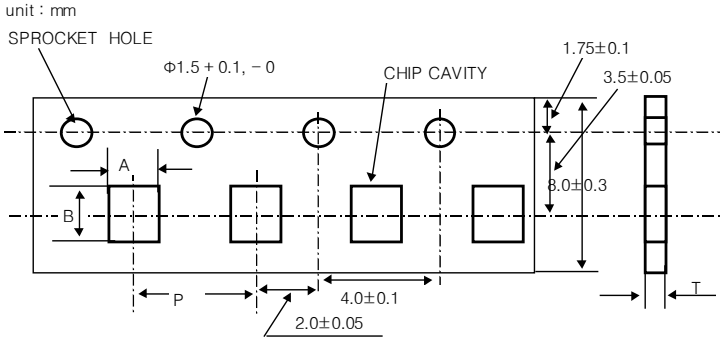

PRODUCT	Type	A	B	P	T(max.)
CHIP BEADS	0603	0.38 ±0.02	0.68 ± 0.02	2.0 ±0.05	0.44
	1005	0.66 ±0.03	1.18 ± 0.03	2.0 ± 0.05	0.64
	1608	1.00 ±0.10	1.80 ± 0.10	4.0 ± 0.1	1.06

■ TAPING DIMENSION / 12mm wide

*Embossing Tape

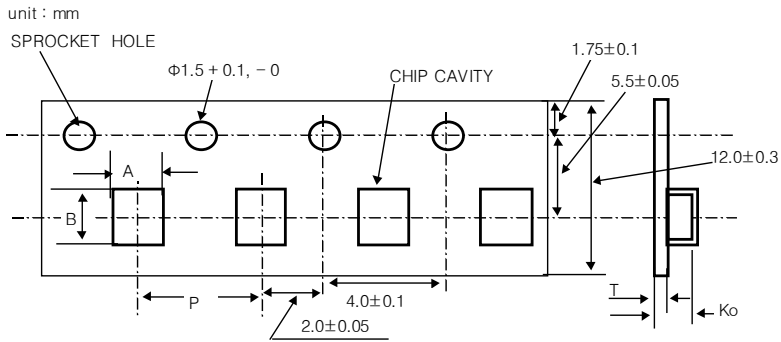

PRODUCT	Type	A ±0.1	B ±0.1	P ±0.1	Ko ±0.1	T(max.)
CHIP BEADS	4516	1.90	4.90	4.0	1.35	0.3
	4532	3.60	4.90	8.0	1.40	0.3
	5750	5.20	6.10	8.0	2.05	0.3

1005 BULK CASSETTE DIMENSION

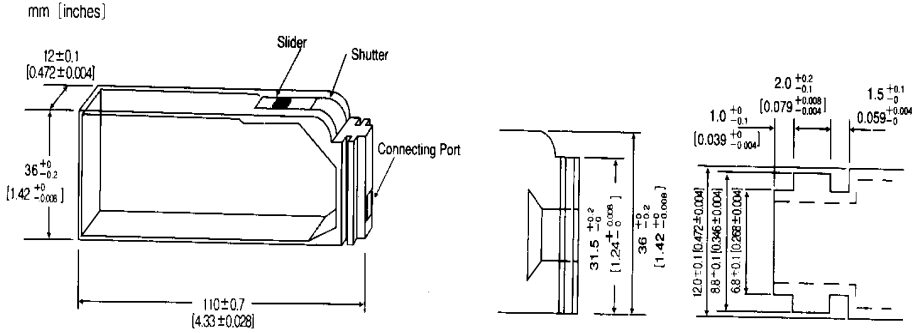

TOP TAPE STRENGTH

* The force for tearing off top tape is 20 to 70 grams in the arrow direction.

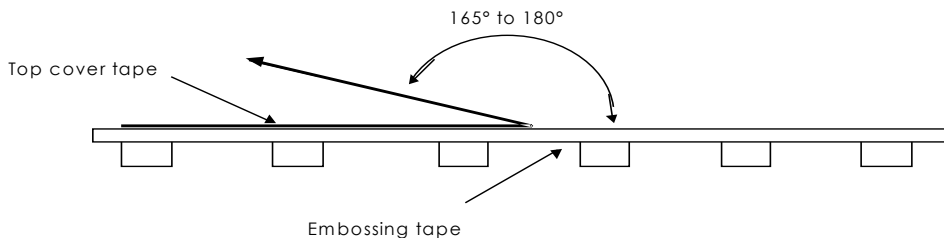

TAPING MATERIAL

* Embossed Tape

* Paper Tape

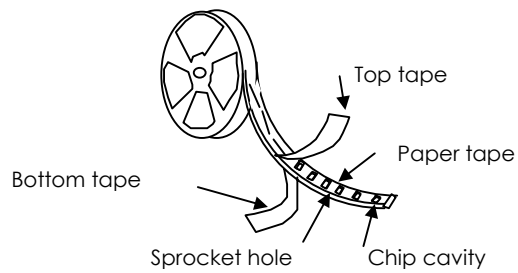
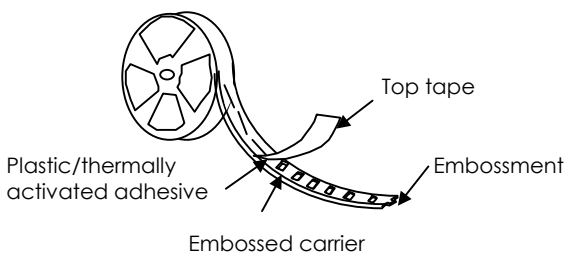

LEADER AND BLANK PORTION

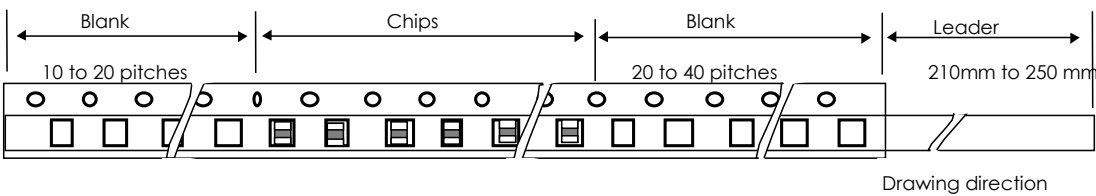

* The pitch holes shift within ±0.3mm for cumulative 10 pitches.

LAND PATTERN DESIGN

CHIP BEADS

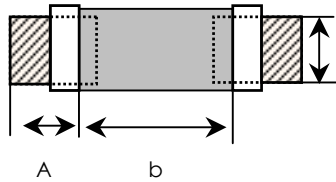

Unit : mm

SIZE	a	b	c
0603	0.22	0.25	0.32
1005	0.7	0.4	0.5
1608	1.0	0.6	0.8
2012	1.0	1.0	1.0
3216	1.1	2.2	1.4
4516	1.5	3.0	1.4
4532	1.8	3.0	3.0
5750	2.0	4.0	5.8

SOLDERING PROFILE

REFLOW SOLDERING PROFILE(Peak 230°C)

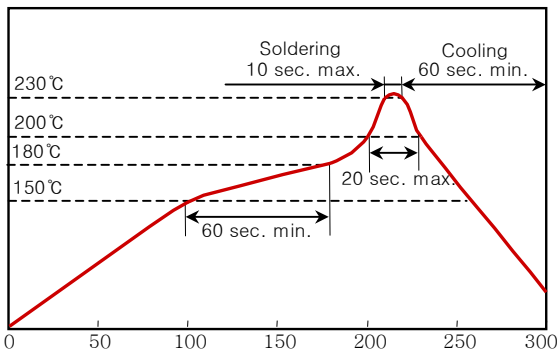

REFLOW SOLDERING PROFILE(Peak 250°C)

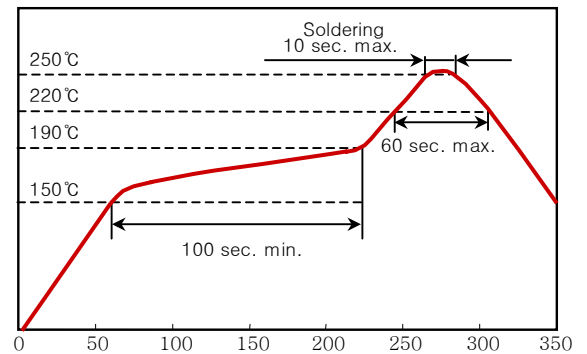

FLOW SOLDERING

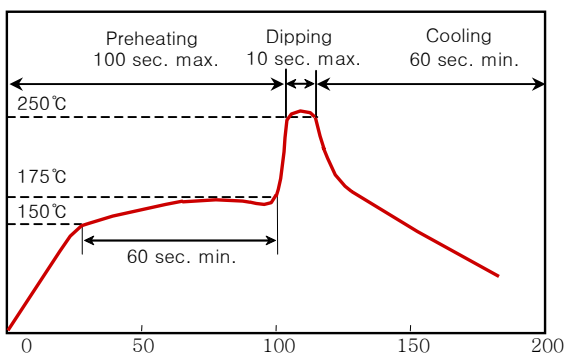

REFLOW SOLDERING PROFILE(Peak 250°C)

