

Slide Potentiometer Standard Type (Super Slide™)

RS 1 Series



Solderable with auto dipping and available in a wide variety.

Rotary Potentiometers

Slide Potentiometers

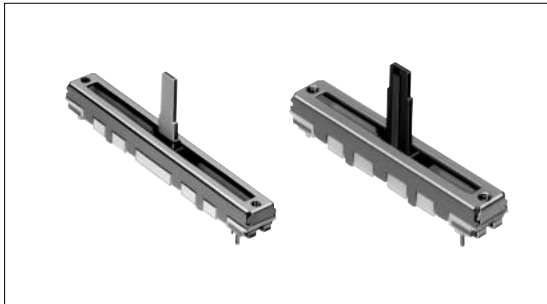

Typical Specifications

Items	Specifications
Total resistance tolerance	± 20%
Maximum operating voltage	50V AC, 10V DC
Operating force	0.3 to 2.5N
Operating life	15,000cycles
Operating temperature range	- 25 to + 70

Product Line

Insulated lever

Number of resistor elements	Travel (mm)	Lever types	Length of lever (mm)	Total resistance (k)	Resistance taper	Detent	Mounting plate	Minimum packing unit (pcs.)	Products No.	Drawing No.
Single-unit	30	J-1	5	10	15A	Without	Without	1,000	RS301111J00P	1
							With		RS301111AJ01R	2
		50	Without	RS301111J00R	1					
			With	RS301111J00W						
	45	A	10	10	1B		Without		RS301111AJ01K	2
							Without		RS301111A01G	3
		B					Without		RS301111C01L	4
							With		RS301111AC00V	5
Dual-unit	30	C	5	3B	Without	RS451111ABA02	6			
		J-1			With	RS30112AC00J	7			
								RS30112AJA02	8	

Metal lever

Number of resistor elements	Travel (mm)	Lever types	Length of lever (mm)	Total resistance (k)	Resistance taper	Detent	Mounting plate	Minimum packing unit (pcs.)	Products No.	Drawing No.		
Single-unit	15	9-1	10	10	15A	Without	With	1,000	RS151111A900B	9		
							Without		RS301111A9012	10		
	30	4	15	20	1B		Without		RS3011114A02	11		
							With		RS301111A602N	12		
	45	9-1	10	10	15A		Without		RS451111A900F	13		
							With		RS4511119A04	14		
		6	15				10		15	Without	RS60111YA600M	15
										Without	RS60111Y19004	16
	60	9-1	10	15	1B		Without		RS60111Y1600Q	17		
							Without		RS451121400A	18		
Dual-unit	45	4	20	20	15A	With	Without	RS45112A400G	19			
							Without	RS60112A600N	20			
	60	6	15	15	Without		RS60112A600U					
					Without							

Note

Products other than those listed in above products are also available. Please contact us for details.

Refer to **P.408** for product varieties.
Refer to **P.408** for configuration details.

Dimensions

Unit:mm

No.	Style	PC board mounting hole dimensions
1		
2		
3		
4		

Rotary Potentiometers
 Slide Potentiometers

General-use Mixer

The length of the operating part (L₁) can be customized. Refer to P.408 for details.

Dimensions

Unit:mm

Rotary
 Potentiometers
 Slide
 Potentiometers

General-use
 Mixer

No.	Style	PC board mounting hole dimensions
5		
6		
7		
8		

The length of the operating part (L₁) can be customized. Refer to P.408 for details.

Dimensions

Unit:mm

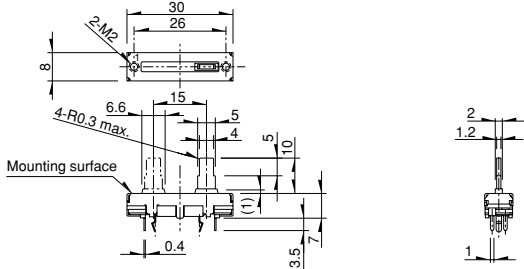
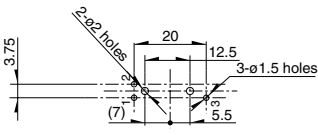
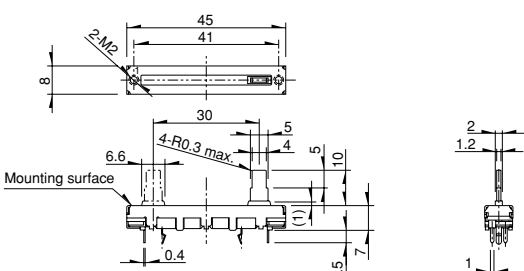
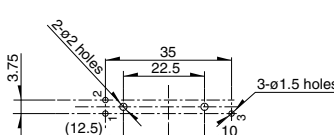
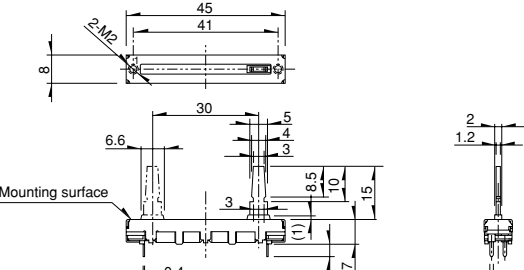
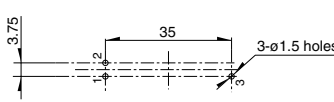
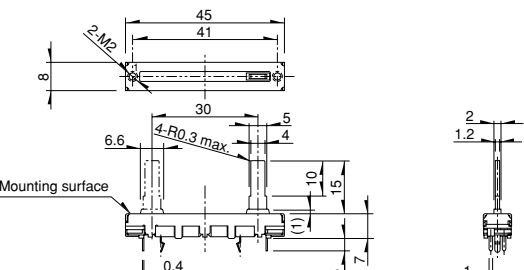
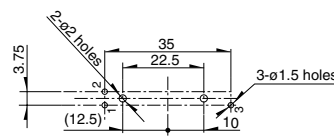
No.	Style	PC board mounting hole dimensions
9		
10		
11		
12		

Rotary Potentiometers
 Slide Potentiometers

General-use Mixer

The length of the operating part(L₁) can be customized. Refer to P.408 for details.

Dimensions

Unit:mm

Rotary
 Potentiometers
**Slide
 Potentiometers**

General-use
 Mixer

No.	Style	PC board mounting hole dimensions
13		
14		
15		
16		

The length of the operating part(L) can be customized. Refer to P.408 for details.

Dimensions

Unit:mm

No.	Style	PC board mounting hole dimensions
17		
18		
19		
20		

Rotary Potentiometers
 Slide Potentiometers

General-use Mixer

The length of the operating part(L;) can be customized. Refer to P.408 for details.

Product Varieties

In addition to the recommended products, the following specifications can also be accommodated.

Travel Distance Variety

Travel (mm)	15	20	30	45	60
-------------	----	----	----	----	----

Total Resistance Variety

Total resistance (k)	10	20	50	100	200
----------------------	----	----	----	-----	-----

Resistance Taper

Resistance taper	1B	4B	10A	15A
------------------	----	----	-----	-----

Note

DC (10VDC) is also available. (Tapped types are not available)

Lever Types

Unit:mm

Metal lever		Insulated lever	
Code	Dimensions	Code	Dimensions
General-use Mixer	9-2 	J-1 	
	9-1 	A 	
	6 	C 	
	4 		

Corresponding Specifications

Unit:mm

Resistance taper	3B, 15C	Insulated lever configuration	
Dust cover	Available	B 	
Tap	Available (Only the center-positioned)		

Terminal Layout/Circuit Diagram

Single-unit	Dual-unit (with lug terminal (RS6011Y only))	Dual-unit
	<p>L : Lug terminal</p>	

Note

marked are specifications recommended by ALPS.

Refer to P.408, 502 for resistance taper.

Rotary
Potentiometers
Slide
Potentiometers

General-use
Mixer

Orders Other Than Recommended Products

When ordering product varieties that are not listed in the Product Line, please specify by referring to the below example.

Sample Part Number



Specify the travel distance from the below codes.

Travel (mm)	Code	Travel (mm)	Code
15	15	45	45
20	20	60	60
30	30		

Number of resistor elements

Single	1 (Enter "Y" for 60 mm travel)
Dual	2

Lever type/Length of operation unit (mm)

Insulated lever

Code	Configuration	Length
J1	J-1	5
0A	A	10
		15
0C	C	10
		15
0B	B	10
		15

Metal lever

Code	Configuration	Length
91	9-1	10
92	9-2	5
04	4	15
		20
06	6	15
		20

Length of operation unit

If the length is less than 10 mm, add a "0" before the number.
(e.g., 5 mm length="05")

Detent

Code	Detent
C0	Without
C1	Center

Mounting plate

Code	Mounting plate
P0	Without
P1	With

Total resistance

Code	Total resistance (kΩ)	Code	Total resistance (kΩ)
103	10	104	100
203	20	204	200
503	50		

Resistance taper

Code	Resistance taper
A	15A
B	1B
D	10A
W	4B
V	3B
C	15C

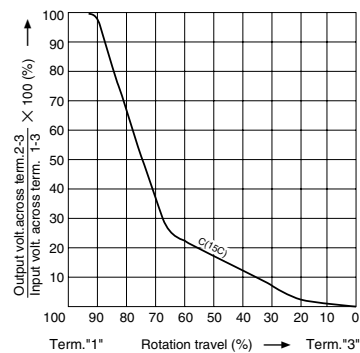
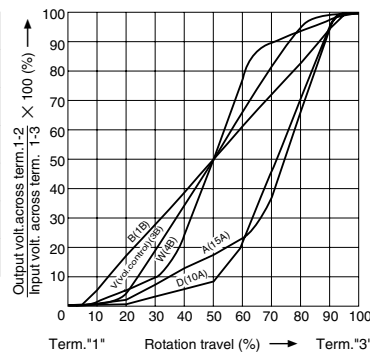

B:For tone & general
V:For vol.





Note

marked are specifications recommended by ALPS.

Rotary Potentiometers
Slide Potentiometers

General-use
Mixer

List of Varieties

Type	Super Slide™		Slim Slide™ (Slim4)				Slim Slide™ (Low-Profile)		
	RS	11	RS		H1		RS	M11	
photo									
Travel (mm)	15 (RS15111) 20 (RS20111) 30 (RS30111) 45 (RS45111) 60 (RS6011Y)	20 (RS20112) 30 (RS30112) 45 (RS45112) 60 (RS60112)	15 (RS15H11) 15 (RS15H13) 20 (RS20H11) 20 (RS20H13) 30 (RS30H11)	15 (RS15H121) 20 (RS20H123) 30 (RS30H121)	15 (RS15H11A) 20 (RS20H11A) 20 (RS20H11C) 30 (RS30H11A)	15 (RS15H12A) 20 (RS20H12A) 30 (RS30H12A)	15 (RS15M11) 20 (RS20M11) 20 (RS20M113)	15 (RS15M11A) 20 (RS20M11A)	
Number of resistor elements	Single-unit	Dual-unit	Single-unit	Dual-unit	Single-unit	Dual-unit	Single-unit		
Direction of lever	Vertical				Horizontal		Vertical	Horizontal	
Electrical Performance	Total resistance (k)	10, 20, 50, 100, 200		5, 10, 20, 50, 100, 200, 250					
	Resistance taper	15A, 1B, 4B, 10A, 3B, 15C		15A, 1B, 3B					
Mechanical Performance	Operating force	0.3 to 2.5N		0.2 to 1.1N		0.15 to 0.8N			
	Stopper strength	50N		30N					
	Lever push-pull strength			30N		20N			
	Lever wobble (mm) Both sides	$\frac{2(2 \times L)}{20}$		1.6 max.					
	Detent slip-out force	Operating force (0.2 to 2N)		Operating force (0.05 to 0.8N)		With detent feeling			
	Lever deviation (mm) One side	0.5 max.							
Solder heat resistance	Manual soldering	350 max. 3s max.							
	Dip soldering	260 max. 5s max.							
Environmental Performance	Cold	- 30 ± 2 for 96h							
	Dry heat	70 ± 2 for 96h				70 ± 2 for 240h			
	Damp heat	40 ± 2 , 90 to 95%RH for 96h							
Page	402		410				416		

Rotary Potentiometers

Slide Potentiometers

General-use

Mixer

Slide Potentiometers Cautions420, 421

Notes

1. "L" in the "Lever Wobble" column of the above table indicates the length of lever.
2. Products other than those listed in the above list are also available. Please contact us for details.
3. The resistance taper specification in () are individually defined.
4. 「RS」 indicates travel.