

TOSHIBA CMOS DIGITAL INTEGRATED CIRCUIT SILICON MONOLITHIC

TC7SL04F, TC7SL04FU

INVERTER

The TC7SL04 is a low voltage operative C²MOS INVERTER fabricated with silicon gate C²MOS technology.

Operating voltage ($V_{CC(opr)}$) is 1~3V equivalent to 1pc or 2pcs of dry cell battery and it achieves low power dissipation.

The internal circuit is composed of 3 stages including buffer output, which enables high noise immunity and stable output.

The input is equipped with protection circuits against static discharge or transient excess voltage.

FEATURES

- High Speed $t_{pd} = 10ns$ (Typ.)
at $V_{CC} = 3V$
- Low Power Dissipation $I_{CC} = 1\mu A$ (Max.)
at $T_a = 25^\circ C$
- High Noise Immunity $V_{NIH} = V_{NIL}$
 $= 28\% V_{CC}$ (Min.)
- Symmetrical Output Impedance $|I_{OH}| = I_{OL} = 1mA$
- Balanced Propagation Delay Time $t_{pLH} \cong t_{pHL}$
- Low Voltage Operating $V_{CC(opr)} = 1\sim 3.6V$

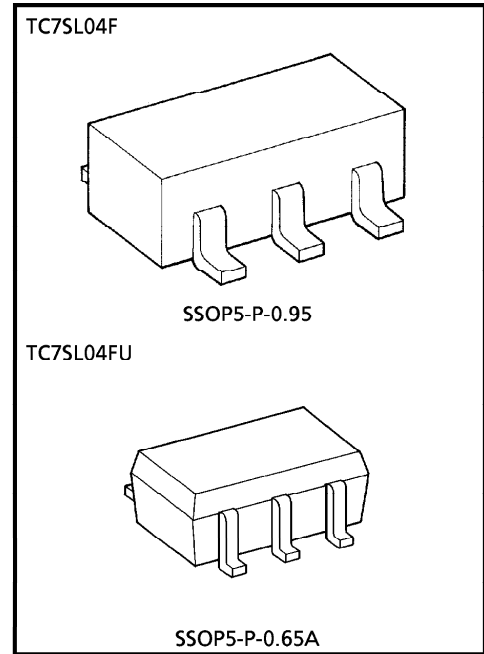

Weight SSOP5-P-0.95 : 0.016g (Typ.)
SSOP5-P-0.65A : 0.006g (Typ.)

MAXIMUM RATINGS

CHARACTERISTIC	SYMBOL	RATING	UNIT
Supply Voltage Range	V_{CC}	-0.5~5	V
DC Input Voltage	V_{IN}	-0.5~ $V_{CC} + 0.5$	V
DC Output Voltage	V_{OUT}	-0.5~ $V_{CC} + 0.5$	V
Input Diode Current	I_{IK}	± 20	mA
Output Diode Current	I_{OK}	± 20	mA
DC Output Current	I_{OUT}	± 12.5	mA
DC V_{CC} /Ground Current	I_{CC}	± 25	mA
Power Dissipation	P_D	200	mW
Storage Temperature	T_{stg}	-65~150	$^\circ C$
Lead Temperature (10s)	T_l	260	$^\circ C$

MARKING

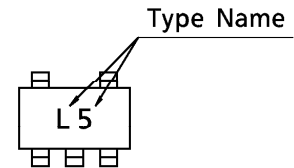

961001EBA2

● TOSHIBA is continually working to improve the quality and the reliability of its products. Nevertheless, semiconductor devices in general can malfunction or fail due to their inherent electrical sensitivity and vulnerability to physical stress. It is the responsibility of the buyer, when utilizing TOSHIBA products, to observe standards of safety, and to avoid situations in which a malfunction or failure of a TOSHIBA product could cause loss of human life, bodily injury or damage to property. In developing your designs, please ensure that TOSHIBA products are used within specified operating ranges as set forth in the most recent products specifications. Also, please keep in mind the precautions and conditions set forth in the TOSHIBA Semiconductor Reliability Handbook.

LOGIC DIAGRAM

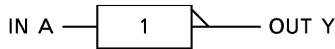

PIN CONNECTION (TOP VIEW)

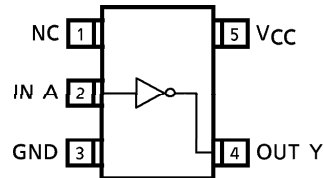

RECOMMENDED OPERATING CONDITIONS

CHARACTERISTIC	SYMBOL	RATING	UNIT
Supply Voltage	V_{CC}	1~3.6	V
Input Voltage	V_{IN}	0~ V_{CC}	V
Output Voltage	V_{OUT}	0~ V_{CC}	V
Operating Temperature	T_{opr}	-40~85	°C
Input Rise and Fall Time	t_r, t_f	0~1000 ($V_{CC} = 1.0V$)	ns
		0~500 ($V_{CC} = 1.5V$)	
		0~400 ($V_{CC} = 3.0V$)	

DC ELECTRICAL CHARACTERISTICS

CHARACTERISTIC	SYMBOL	TEST CIRCUIT	TEST CONDITION	V_{CC}	$T_a = 25^{\circ}C$			$T_a = -40 \sim 85^{\circ}C$		UNIT										
					MIN.	TYP.	MAX.	MIN.	MAX.											
High-Level Input Voltage	V_{IH}	—	—	1.0	0.75	—	—	0.75	—	V										
				1.5	1.05	—	—	1.05	—											
				3.0	2.10	—	—	2.10	—											
Low-Level Input Voltage	V_{IL}	—	—	1.0	—	—	0.25	—	0.25	V										
				1.5	—	—	0.45	—	0.45											
				3.0	—	—	0.90	—	0.90											
High-Level Output Voltage	V_{OH}	—	$V_{IN} = V_{IL}$	$I_{OH} = -20\mu A$	1.0	0.9	1.0	—	0.9	V										
					1.5	1.4	1.5	—	1.4		—									
					3.0	2.9	3.0	—	2.9		—									
Low-Level Output Voltage	V_{OL}	—	$V_{IN} = V_{IH}$	$I_{OL} = 20\mu A$	1.0	—	0.0	0.1	—	0.1	V									
					1.5	—	0.0	0.1	—	0.1										
					3.0	—	0.0	0.1	—	0.1										
Input Leakage Current	I_{IN}	—	$V_{IN} = V_{CC}$ or GND	3.6	—	—	± 0.1	—	± 1.0	μA										
											Quiescent Supply Current	I_{CC}	—	$V_{IN} = V_{CC}$ or GND	3.6	—	—	1.0	—	10.0

961001EBA2'

- The products described in this document are subject to foreign exchange and foreign trade control laws.
- The information contained herein is presented only as a guide for the applications of our products. No responsibility is assumed by TOSHIBA CORPORATION for any infringements of intellectual property or other rights of the third parties which may result from its use. No license is granted by implication or otherwise under any intellectual property or other rights of TOSHIBA CORPORATION or others.
- The information contained herein is subject to change without notice.

AC ELECTRICAL CHARACTERISTICS ($C_L = 15\text{pF}$, Input $t_r = t_f = 6\text{ns}$, $V_{CC} = 3.3 \pm 0.3\text{V}$)

CHARACTERISTIC	SYMBOL	TEST CIRCUIT	TEST CONDITION	Ta = 25°C			UNIT
				MIN.	TYP.	MAX.	
Output Transition Time	t_{TLH} t_{THL}	—	—	—	5.0	9.0	ns
Propagation Delay Time	t_{PLH} t_{PHL}	—	—	—	7.5	13.0	ns

AC ELECTRICAL CHARACTERISTICS ($C_L = 25\text{pF}$, Input $t_r = t_f = 6\text{ns}$)

CHARACTERISTIC	SYMBOL	TEST CIRCUIT	TEST CONDITION	V _{CC}	Ta = 25°C			Ta = -40~85°C		UNIT
					MIN.	TYP.	MAX.	MIN.	MAX.	
Output Transition Time	t_{TLH} t_{THL}	—	—	1.0	—	70	170	—	240	ns
				1.5	—	25	45	—	55	
				3.0	—	10	15	—	20	
Propagation Delay Time	t_{PLH} t_{PHL}	—	—	1.0	—	70	170	—	210	ns
				1.5	—	25	45	—	55	
				3.0	—	10	15	—	20	
Input Capacitance	C_{IN}	—	—	—	5	10	—	10	pF	
Power Dissipation Capacitance	C_{PD}	—	Note (1)	—	10	—	—	—		

Note (1) : C_{PD} defined as the value of internal equivalent capacitance of IC which is calculated from the operating current consumption without load (refer to Test Circuit).

Average operating current can be obtained by the equation as follows.

$$I_{CC(opr)} = C_{PD} \cdot V_{CC} \cdot f_{IN} + I_{CC}$$

SWITCHING CHARACTERISTICS TEST CIRCUIT

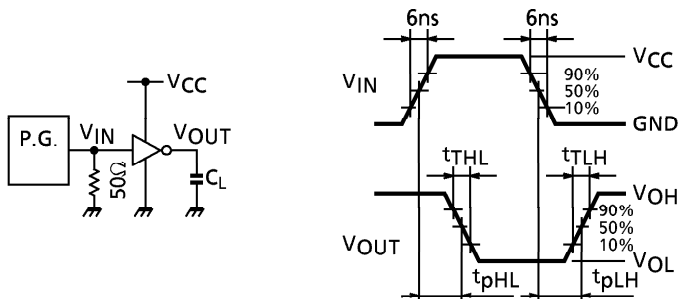

I_{CC(opr)} TEST CIRCUIT

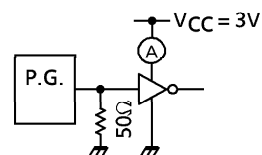

Input waveform is the same as that in case of switching characteristics test.

OUTLINE DRAWING
SSOP5-P-0.95

Unit : mm



Weight : 0.016g (Typ.)

OUTLINE DRAWING
SSOP5-P-0.65A

Unit : mm

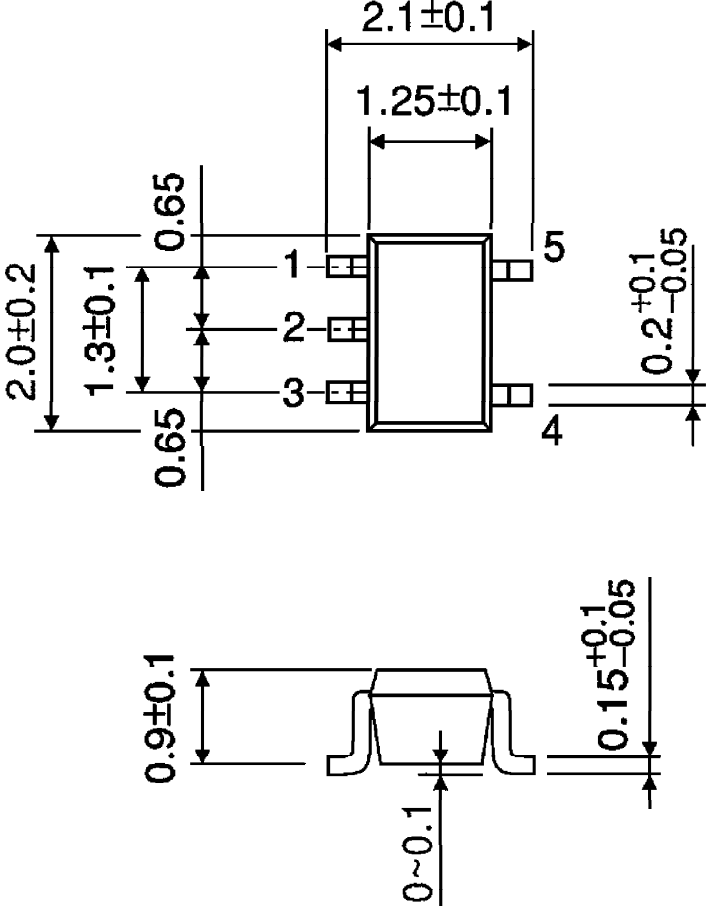

Weight : 0.006g (Typ.)