

Polypropylene (PP) Capacitors for Pulse Applications with Metal Foil Electrodes, Schoopage Contacts, Double-Sided Metallization and Self-Healing Internal Series Connection for Highest Current Carrying Capability PCM 15 mm to 37.5 mm

Special Features

- Extremely high pulse duty
- Self-healing
- Internal series connection
- Very low dissipation factor
- Negative capacitance change versus temperature
- According to RoHS 2002/95/EC

Typical Applications

For high pulse and high frequency applications e.g.

- Switch mode power supplies
- Converters in drives and power electronics
- Deflection systems in monitors and TV-sets
- Electronic ballasts

Construction

Dielectric:

Polypropylene (PP) film

Capacitor electrodes:

Aluminium foil and double-sided metallized plastic film

Internal construction:

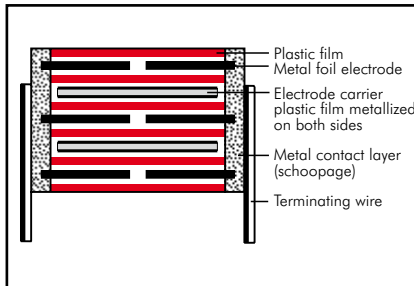

Encapsulation:

Solvent-resistant, flame-retardant plastic case with epoxy resin seal, UL 94 V-0

Terminations:

Tinned wire.

Marking:

Colour: Red. Marking: Black.
Epoxy resin seal: Yellow

Electrical Data

Capacitance range:

100 pF to 0.22 μF (E12-values on request)

Rated voltages:

400 VDC, 630 VDC, 1000 VDC, 1250 VDC, 1600 VDC, 2000 VDC, 4000 VDC, 6000 VDC

Capacitance tolerances:

±20%, ±10%, ±5% (other tolerances are available subject to special enquiry)

Operating temperature range:

-55° C to +100° C

Climatic test category:

55/100/56 in accordance with IEC

Insulation resistance at +20° C:

$C \leq 0.1 \mu\text{F}$: $\geq 1 \times 10^5 \text{ M}\Omega$

(mean value: $5 \times 10^5 \text{ M}\Omega$)

$C > 0.1 \mu\text{F}$: $\geq 30\,000 \text{ sec (M}\Omega \times \mu\text{F)}$

(mean value: 100\,000 sec)

Measuring voltage: 100 V/1 min.

Test voltage:

$2 U_r$, 2 sec / 6 kV: $1.6 U_r$, 2 sec.

Maximum pulse rise time:

Capacitance pF/μF	max. pulse rise time V/μsec at $T_A < 40^\circ \text{C}$							
	400VDC	630VDC	1000VDC	1250VDC	1600VDC	2000VDC	4000VDC	6000VDC
100 ... 220	-	-	-	-	56000	56000	-	-
330 ... 680	-	-	-	-	51000	56000	56000	56000
1000 ... 2200	29000	29000	29000	29000	46000	51000	51000	51000
3300 ... 6800	9000	14000	27000	29000	29000	29000	29000	29000
0.01 ... 0.022	9000	11000	11000	11000	11000	13000	13000	13000
0.033 ... 0.068	9000	11000	11000	11000	11000	11000	-	-
0.1 ... 0.22	7000	11000	11000	11000	11000	-	-	-

for pulses equal to the rated voltage

Mechanical Tests

Pull test on leads:

$d \leq 0.8 \phi$: 10 N in direction of leads

$d > 0.8 \phi$: 20 N in direction of leads

according to IEC 60068-2-21

Vibration:

6 hours at 10...2000 Hz and 0.75 mm

displacement amplitude or 10 g in

accordance with IEC 60068-2-6

Low air density:

1kPa = 10 mbar in accordance with

IEC 60068-2-13

Bump test:

4000 bumps at 390 m/sec²

in accordance with IEC 60068-2-29

Dissipation factors at +20° C: tan δ

at f	$C \leq 0.1 \mu\text{F}$	$0.1 \mu\text{F} < C \leq 0.22 \mu\text{F}$
1 kHz	$\leq 3 \times 10^{-4}$	$\leq 3 \times 10^{-4}$
10 kHz	$\leq 4 \times 10^{-4}$	$\leq 6 \times 10^{-4}$
100 kHz	$\leq 10 \times 10^{-4}$	-

Dielectric absorption:

0.05%

Voltage derating:

A voltage derating factor of 1.35 % per K

must be applied from +85° C for DC

voltages and from +75° C for AC

voltages

Reliability:

Operational life > 300\,000 hours

Failure rate < 1 fit ($0.5 \times U_r$ and 40° C)

Packing

Available taped and reeled up to and

including case size 15 x 26 x 31.5 /

PCM 27.5 mm.

Detailed taping information and graphs

at the end of the catalogue.

For further details and graphs please

refer to Technical Information.

Continuation

General Data

Capacitance	400 VDC/250 VAC*				630 VDC/400 VAC*				1000 VDC/600 VAC*				1250 VDC/600 VAC*			
	W	H	L	PCM**	W	H	L	PCM**	W	H	L	PCM**	W	H	L	PCM**
1000 pF	5	11	18	15	5	11	18	15	5	11	18	15	5	11	18	15
1500 „	5	11	18	15	5	11	18	15	5	11	18	15	5	11	18	15
2200 „	5	11	18	15	5	11	18	15	5	11	18	15	5	11	18	15
3300 „	5	11	18	15	5	11	18	15	5	11	18	15	6	12.5	18	15
4700 „	5	11	18	15	5	11	18	15	6	12.5	18	15	7	14	18	15
6800 „	5	11	18	15	6	12.5	18	15	7	14	18	15	8	15	18	15*
													5	14	26.5	22.5*
0.01 µF	5	11	18	15	7	14	18	15*	8	15	18	15*	7	16.5	26.5	22.5
					5	14	26.5	22.5*	6	15	26.5	22.5*				
0.015 „	6	12.5	18	15	8	15	18	15*	6	15	26.5	22.5	8.5	18.5	26.5	22.5
					6	15	26.5	22.5*								
0.022 „	7	14	18	15*	7	16.5	26.5	22.5	8.5	18.5	26.5	22.5	10.5	20.5	26.5	22.5
	5	14	26.5	22.5*												
0.033 „	8	15	18	15*	8.5	18.5	26.5	22.5	10.5	20.5	26.5	22.5*	11	21	31.5	27.5*
	6	15	26.5	22.5*					9	19	31.5	27.5*	9	19	41.5	37.5*
0.047 „	7	16.5	26.5	22.5	10.5	20.5	26.5	22.5*	11	21	31.5	27.5	13	24	31.5	27.5*
					9	19	31.5	27.5*					11	22	41.5	37.5*
0.068 „	8.5	18.5	26.5	22.5	11	21	31.5	27.5*	13	24	31.5	27.5*	11	22	41.5	37.5
					9	19	41.5	37.5*	11	22	41.5	37.5*				
0.1 µF	10.5	20.5	26.5	22.5*	13	24	31.5	27.5*	13	24	41.5	37.5	15	26	41.5	37.5
	9	19	31.5	27.5*	11	22	41.5	37.5*								
0.15 „	11	21	31.5	27.5	13	24	41.5	37.5	15	26	41.5	37.5	17	29	41.5	37.5
0.22 „	13	24	31.5	27.5	15	26	41.5	37.5	19	32	41.5	37.5	19	32	41.5	37.5

* AC voltage: $f \leq 1000 \text{ Hz}$; $1.4 \times U_{\text{rms}} + U_{\text{DC}} \leq U_r$

** PCM = Printed circuit module = lead spacing

* On ordering please state the required PCM (lead spacing).
If not specified, smaller PCM will be booked.

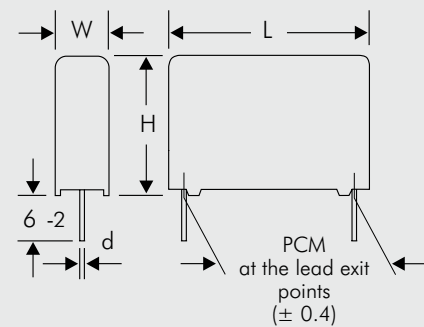

ϕd	PCM
0.8	15 - 27.5
1.0	37.5

Dims. in mm.

Ionisation inception level in isolated cases may be lower than admissible rated AC voltage.

Taped version see page 121.

Rights reserved to amend design data without prior notification.

Continuation page 76.

Continuation

General Data

Capacitance	1600 VDC/650 VAC*				2000 VDC/700 VAC*				4000 VDC/700 VAC*				6000 VDC/700 VAC*			
	W	H	L	PCM**	W	H	L	PCM**	W	H	L	PCM**	W	H	L	PCM**
100 pF	5	11	18	15	5	11	18	15								
150 "	5	11	18	15	5	11	18	15								
220 "	5	11	18	15	5	11	18	15								
330 "	5	11	18	15	6	12.5	18	15								
470 "	5	11	18	15	6	12.5	18	15	5	14	26.5	22.5	5	14	26.5	22.5
680 "	5	11	18	15	6	12.5	18	15	5	14	26.5	22.5	5	14	26.5	22.5
1000 pF	6	12.5	18	15*	7	14	18	15*	5	14	26.5	22.5	5	14	26.5	22.5
	5	14	26.5	22.5*	5	14	26.5	22.5*								
1500 "	7	14	18	15*	6	15	26.5	22.5	7	16.5	26.5	22.5	7	16.5	26.5	22.5
	5	14	26.5	22.5*												
2200 "	8	15	18	15*	7	16.5	26.5	22.5	8.5	18.5	26.5	22.5	10.5	20.5	26.5	22.5
	5	14	26.5	22.5*												
3300 "	6	15	26.5	22.5	7	16.5	26.5	22.5	10.5	20.5	26.5	22.5	10.5	20.5	26.5	22.5
4700 "	7	16.5	26.5	22.5	8.5	18.5	26.5	22.5	11	21	31.5	27.5	11	21	31.5	27.5
6800 "	8.5	18.5	26.5	22.5	10.5	20.5	26.5	22.5	13	24	31.5	27.5	13	24	31.5	27.5
0.01 µF	10.5	20.5	26.5	22.5	11	21	31.5	27.5	15	26	31.5	27.5	15	26	31.5	27.5
0.015 "	11	21	31.5	27.5	13	24	31.5	27.5	13	24	41.5	37.5	13	24	41.5	37.5
0.022 "	11	21	31.5	27.5	15	26	31.5	27.5*	17	29	41.5	37.5	17	29	41.5	37.5
					13	24	41.5	37.5*								
0.033 "	13	24	31.5	27.5*	13	24	41.5	37.5								
	13	24	41.5	37.5*												
0.047 "	13	24	41.5	37.5	17	29	41.5	37.5								
0.068 "	15	26	41.5	37.5	19	32	41.5	37.5								
0.1 µF	17	29	41.5	37.5												

* On ordering please state the required PCM (lead spacing). If not specified, smaller PCM will be booked.

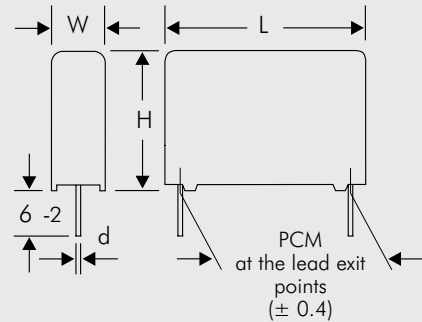

* AC voltage: $f \leq 1000 \text{ Hz}$; $1.4 \times U_{\text{rms}} + \text{UDC} \leq U_r$

** PCM = Printed circuit module = lead spacing

Dims. in mm.

Ionisation inception level in isolated cases may be lower than admissible rated AC voltage.

Taped version see page 121.

Rights reserved to amend design data without prior notification.

∅ d	PCM
0.8	15 - 27.5
1.0	37.5

Permissible AC voltage in relation to frequency at 10° C internal temperature rise (general guide).

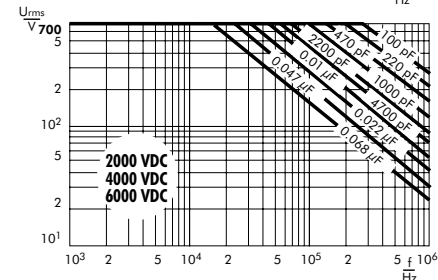
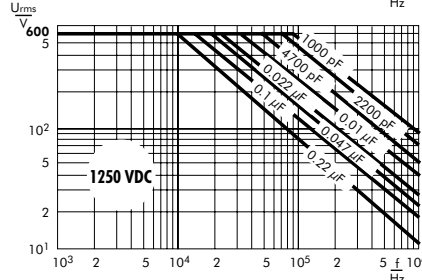
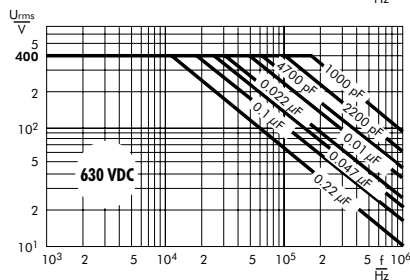
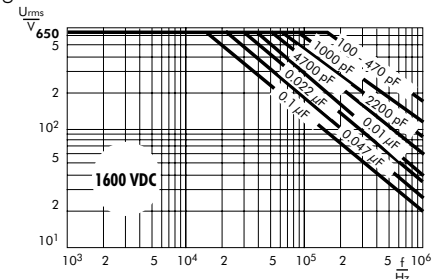
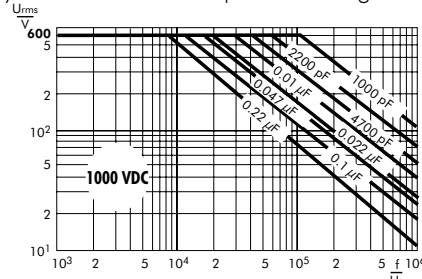
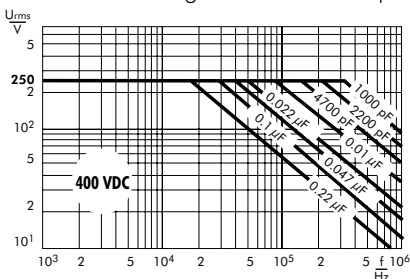

Recommendation for Processing and Application of Through-Hole Capacitors

Soldering Process

A preheating of through-hole WIMA capacitors is allowed for temperatures $T_{\max} < 100^{\circ}\text{C}$. In practice a preheating duration of $t < 5$ min. has been proven to be best.

Single wave soldering

Soldering bath temperature: $T < 260^{\circ}\text{C}$
Immersion time: $t < 5$ sec

Double wave soldering

Soldering bath temperature: $T < 260^{\circ}\text{C}$
Immersion time: $2 \times t < 3$ sec

Due to different soldering processes and heat requirements the graphs are to be regarded as a recommendation only.

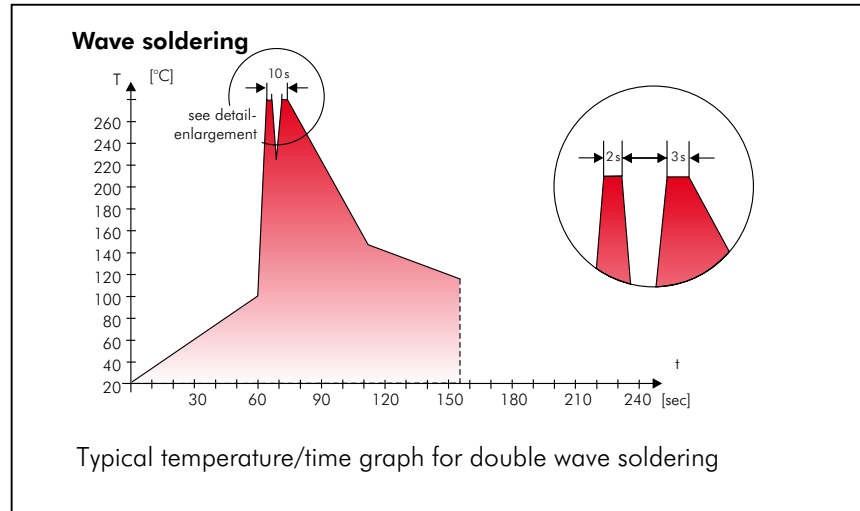

WIMA Quality and Environmental Philosophy

ISO 9001:2000 Certification

ISO 9001:2000 is an international basic standard of quality assurance systems for all branches of industry. The approval according to ISO 9001:2000 of our factories by the VDE inspectorate certifies that organisation, equipment and monitoring of quality assurance in our factories correspond to internationally recognized standards.

WIMA WPCS

The WIMA Process Control System (WPCS) is a quality surveillance and optimization system developed by WIMA. WPCS is a major part of the quality-oriented WIMA production. Points of application of WPCS during production process:

- incoming material inspection
- metallization
- film inspection
- schoopage
- pre-healing
- lead attachment
- cast resin preparation/encapsulation
- 100% final inspection
- AQL check

WIMA Environmental Policy

All WIMA capacitors, irrespective of whether through-hole devices or SMD, are made of environmentally friendly materials. Neither during manufacture nor in the product itself any toxic substances are used, e.g.

- Lead
- PCB
- CFC
- Hydrocarbon chloride
- Chromium 6+
- PBB/PBDE
- Arsenic
- Cadmium
- Mercury
- etc.

We merely use pure, recyclable materials for packing our components, such as:

- carton
- cardboard
- adhesive tape made of paper
- polystyrene

We almost completely refrain from using packing materials such as:

- foamed polystyrene (Styropor®)
- adhesive tapes made of plastic
- metal clips

RoHS Compliance

According to the RoHS Directive 2002/95/EC certain hazardous substances like e.g. lead, cadmium, mercury must not be used any longer in electronic equipment as of July 1st, 2006. For the sake of the environment WIMA has refrained from using such substances since years already.



WIMA Kondensatoren sind bleifrei konform RoHS 2002/95/EG

WIMA capacitors are lead free in accordance with RoHS 2002/95/EC

Tape for lead-free WIMA capacitors

DIN EN ISO 14001:2005

WIMA's environmental management has been established in accordance with the guidelines of DIN EN ISO 14001:2005. The certification has been granted in June 2006.

Typical Dimensions for Taping Configuration

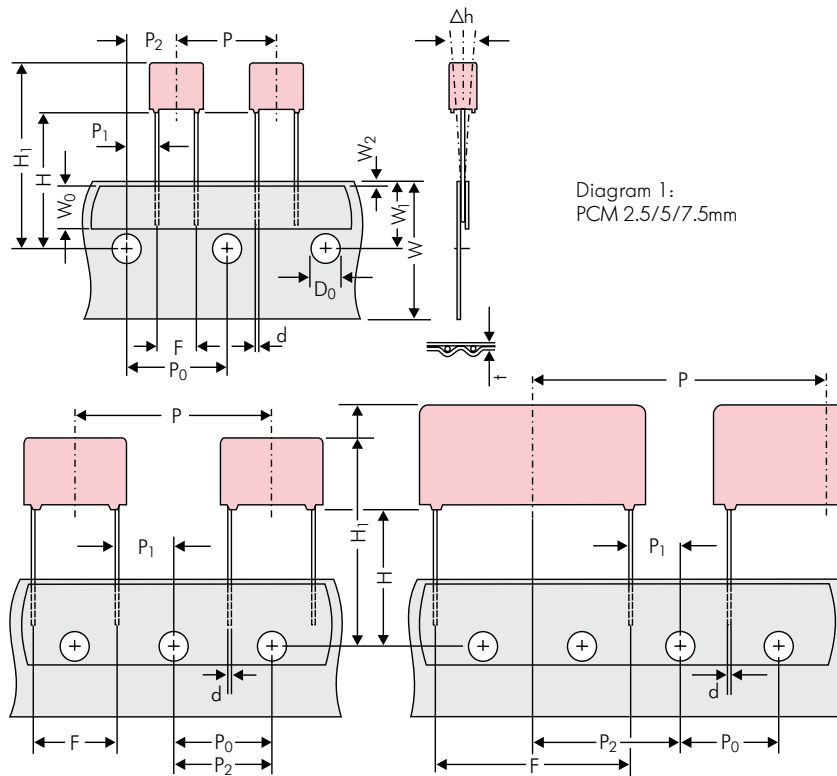

Diagram 1:
PCM 2.5/5/7.5mm

Diagram 2: PCM 10/15 mm

Diagram 3: PCM 22.5 and 27.5*mm

*PCM 27.5 tapping possible with two feed holes between components

Designation	Symbol	Dimensions for Radial Taping						
		PCM 2.5 tapping	PCM 5 tapping	PCM 7.5 tapping	PCM 10 tapping*	PCM 15 tapping*	PCM 22.5 tapping	PCM 27.5 tapping
Carrier tape width	W	18.0 ±0.5	18.0 ±0.5	18.0 ±0.5	18.0 ±0.5	18.0 ±0.5	18.0 ±0.5	18.0 ±0.5
Hold-down tape width	W ₀	6.0 for hot-sealing adhesive tape	6.0 for hot-sealing adhesive tape	12.0 for hot-sealing adhesive tape	12.0 for hot-sealing adhesive tape	12.0 for hot-sealing adhesive tape	12.0 for hot-sealing adhesive tape	12.0 for hot-sealing adhesive tape
Hole position	W ₁	9.0 ±0.5	9.0 ±0.5	9.0 ±0.5	9.0 ±0.5	9.0 ±0.5	9.0 ±0.5	9.0 ±0.5
Hold-down tape position	W ₂	0.5 to 3.0 max.	0.5 to 3.0 max.	0.5 to 3.0 max.	0.5 to 3.0 max.	0.5 to 3.0 max.	0.5 to 3.0 max.	0.5 to 3.0 max.
Feed hole diameter	D ₀	4.0 ±0.2	4.0 ±0.2	4.0 ±0.2	4.0 ±0.2	4.0 ±0.2	4.0 ±0.2	4.0 ±0.2
Pitch of component	P	12.7 ±1.0	12.7 ±1.0	12.7 ±1.0	25.4 ±1.0	25.4 ±1.0	38.1 ±1.5	38.1 ±1.5 or 50.8 ±1.5
Feed hole pitch	P ₀	12.7 ±0.3 cumulative pitch error max. 1.0 mm/20 pitch	12.7 ±0.3 cumulative pitch error max. 1.0 mm/20 pitch	12.7 ±0.3 cumulative pitch error max. 1.0 mm/20 pitch	12.7 ±0.3 cumulative pitch error max. 1.0 mm/20 pitch	12.7 ±0.3 cumulative pitch error max. 1.0 mm/20 pitch	12.7 ±0.3 cumulative pitch error max. 1.0 mm/20 pitch	12.7 ±0.3 cumulative pitch error max. 1.0 mm/20 pitch
Feed hole centre to lead	P ₁	5.1 ±0.5	3.85 ±0.7	2.6 ±0.7	7.7 ±0.7	5.2 ±0.7	7.8 ±0.7	5.3 ±0.7
Hole centre to component centre	P ₂	6.35 ±1.3	6.35 ±1.3	6.35 ±1.3	12.7 ±1.3	12.7 ±1.3	19.05 ±1.3	19.05 ±1.3
Feed hole centre to bottom edge of the component	H _▲	16.5 ±0.3 18.5 ±0.5	16.5 ±0.3 18.5 ±0.5	16.5 ±0.5 18.5 ±0.5	16.5 ±0.5 18.5 ±0.5	16.5 ±0.5 18.5 ±0.5	16.5 ±0.5 18.5 ±0.5	16.5 ±0.5 18.5 ±0.5
Feed hole centre to top edge of the component	H ₁	H+H _{component} < H ₁ 32.25 max.	H+H _{component} < H ₁ 32.25 max.	H+H _{component} < H ₁ 24.5 to 31.5	H+H _{component} < H ₁ 25.0 to 31.5	H+H _{component} < H ₁ 26.0 to 37.0	H+H _{component} < H ₁ 30.0 to 43.0	H+H _{component} < H ₁ 35.0 to 45.0
Lead spacing at upper edge of carrier tape	F	2.5 ±0.5	5.0 ^{+0.8} _{-0.2}	7.5 ±0.8	10.0 ±0.8	15 ±0.8	22.5 ±0.8	27.5 ±0.8
Lead diameter	d	0.4 ±0.05	0.5 ±0.05	0.5 ±0.05 or 0.6 ^{+0.06} _{-0.05}	0.5 ±0.05 or 0.6 ^{+0.06} _{-0.05}	0.8 ^{+0.08} _{-0.05}	0.8 ^{+0.08} _{-0.05}	0.8 ^{+0.08} _{-0.05}
Component alignment	Δh	± 2.0 max.	± 2.0 max.	± 3.0 max.	± 3.0 max.	± 3.0 max.	± 3.0 max.	± 3.0 max.
Total tape thickness	t	0.7 ±0.2	0.7 ±0.2	0.7 ±0.2	0.7 ±0.2	0.7 ±0.2	0.7 ±0.2	0.7 ±0.2
Package (see also page 122)	▲	ROLL/AMMO			AMMO			
		REEL ø 360 max. ø 30 ±1	B 52 ±2 58 ±2 } depending on comp. dimensions		REEL ø 360 max. ø 30 ±1	52 ±2 58 ±2 or 66 ±2	REEL ø 500 max. ø 25 ±1	54 ±2 60 ±2 68 ±2 } depending on PCM and component dimensions
Unit		see details page 124.						

▲ Please give „H“ dimensions and desired packaging type when ordering.

• Diameter of leads see General Data.

* PCM 10 and PCM 15 can be crimped to PCM 7.5.

Position of components according to PCM 7.5 (sketch 11). P₀ = 12.7 or 15.0 is possible

Dims in mm.

Please clarify customer-specific deviations with the manufacturer.